

CATALOG

**WATER PUMPS**  
**OIL PUMPS**  
**FUEL FEED PUMPS**  
**REPAIR KITS**  
**HOUSINGS**  
**PARTS**



**FAMCO**<sup>®</sup>  
**GENUINE**

**2024<sup>1</sup>**  
PRODUCT  
CATALOG

[www.famco.com.tr](http://www.famco.com.tr)

VOLVO

SCANIA

MERCEDES-BENZ

MAN

DAF

RENAULT

IVECO

OTHERS

## ABOUT US

Founded in 1967 Fa-Me Automotive, at the beginning of the 2000s started production of water pumps for heavy trucks and commercial vehicles. FAMCO brand, which is being exported to more than 45 countries became one of the preferred brands, because of aiming at improving quality and customer satisfaction.

By following the new technologies, producing with renewed technical equipment and in accordance with ISO9001:2015 certificate, the company is continuing to expand the range of water pumps for VOLVO, DAF, SCANIA, MAN, MERCEDES, RENAULT, IVECO and OTHERS heavy trucks.

*From part to  
the Whole...*

## OUR MISSION

Our mission is to protect, expand and maintain the superior service concept and quality, and share it with the world as the best in its sector.

## OUR VISION

Our vision is to meet the customers expectations and demands quickly and completely, and ensure the continuity of customers satisfaction.

## FAMCO IS;

- High technologies;
- Continuous improvement of product and service quality;
- Two-step leakage testing system;
- Quality tested by hundreds of thousands of vehicles all over the world.





## PRODUCTION

For today the company is producing more than 150 kinds of water pumps for heavy trucks like IVECO, SCANIA, VOLVO, MAN, MERCEDES, RENAULT, DAF and OTHERS. The product development department is working on expanding the range and satisfying all the needs of our customers.

## QUALITY

All products comply with ISO9001:2015 certificate and are covered by an international warranty of 1 year or 100000 km.

Almost all components, except bearing, mechanical seal and raw materials are producing directly at the factory. 92% of suppliers belong to an A-group. The quality control department constantly monitors changes on the market and chooses the most reliable suppliers from a huge variety of offers.

## EXPORT

FAMCO is exporting water pumps to more than 45 countries.

Germany  
Spain  
Estonia  
Italy  
Greece  
Portugal  
Poland  
The UK  
The Netherlands  
Belgium

Ireland  
Israil  
Kyrgyzstan  
Russia  
South Korea  
Colombia  
Peru  
Chile  
Syria  
Libya  
UAE

Iran  
Iraq  
Egypt  
Yemen  
Jordan  
Lebanon  
Tunisia  
South Africa  
Ethiopia  
Tanzania  
Sri Lanka  
U.S.A....

VOLVO

SCANIA

MERCEDES-BENZ

MAN

DAF

RENAULT

IVECO

OTHERS

VOLVO

SCANIA

MERCEDES-BENZ

MAN

DAF

RENAULT

IVECO

OTHERS



*Quality  
is important*

**FAMCO**<sup>®</sup>



[www.famco.com.tr](http://www.famco.com.tr)

# INDEX

for VOLVO	6-37
for SCANIA	38-53
for MERCEDES-BENZ	54-97
for MAN	98-129
for DAF	130-147
for RENAULT	148-171
for IVECO	172-186
for OTHERS	187-192

VOLVO

SCANIA

MERCEDES-BENZ

MAN

DAF

RENAULT

IVECO

OTHERS

VOLVO

SCANIA

MERCEDES-BENZ

MAN

DAF

RENAULT

IVECO

OTHERS

FOR VOLVO



[www.famco.com.tr](http://www.famco.com.tr)

WATER PUMP

**12.1012.00**

Replaced Old Famco No : FM100A01000

Oem Ref	Vehicle/Model	Engine
1699789	N 10	TD 100 A
1698619	NL 10/S	TD 101 USA
1545427	N 10 Mark II	
467915	CH 306 000→	
467204		
5002878		
5001385		
8112522		



Package Weight : **17,350 kg**  
Package Dimensions : **23x35x22,5cm**



**01.3102.00**  
Ref : 467181



**01.3101.00**  
Ref : 423125



**03.2103.00**  
Ref : 421082



**03.3102.00**



**01.2108.00**  
Ref : 1698603  
317012

REPAIR KIT

**15.1012.00**

Replaced Old Famco No : FM100D21010

Oem Ref	Vehicle/Model	Engine
276800	F 10	D 100 B
275618	N 10	TD 100 A/B/BG/G/GA
275986	NL 10/S	FD 101 G/GA/USA
876435	N 10 Mark II	TD 102/103

\* water pump repair kit with bearings (24 parts)

Remarks

to fit water pumps:

1699789	1545248	1698618
1699788	467915	1698619
1545427	467907	



WATER PUMP

**12.1022.00**

Replaced Old Famco No : FM100B01000

Oem Ref	Vehicle/Model	Engine
1699785	F 10	TD 100 A/B
1698617		TD 100 BG
1698615		TD 100 GA
467906		TD 101 G/GA
422312		TD 102/103
8112519		
5002208		
5001637		
5007637		



Package Weight : **16,400 kg**  
 Package Dimensions : **23x35x22,5cm**



**01.3104.00**  
Ref : 467576



**01.3103.00**  
Ref : 467575



**09.5163.00**  
Ref : 1545244



**09.5107.00**  
Ref : 423129



**09.5106.00**  
Ref : 423127

REPAIR KIT

**15.1022.00**

Replaced Old Famco No : FM100D11010

Oem Ref	Vehicle/Model	Engine
F 10		D 100 B
N 10v		TD 100 A/B/BG/G/GA
NL 10/S		FD 101 G/GA/USA
N 10 Mark II		TD 102/103

Remarks

to fit water pumps:

1699785 1545246  
 1698617 467906  
 1698615 422312





WATER PUMP

**12.1042.00**

Replaced Old Famco No : FM101G01000

Oem Ref	Vehicle/Model	Engine
1699788	N 10	TD 100 B/G
1698618	NL 10/S	TD 101 G
1545248	N 10 Mark II	TD 102
467907		
467686		
8112521		
5001797		
5002804		



Package Weight : **16,700 kg**  
Package Dimensions : **23x35x22,5cm**



**01.3105.00**  
Ref : 467687



**01.3103.00**  
Ref : 467575



**09.5105.00**



**09.5108.00**



**16.1012.00**

REPAIR KIT

**15.1042.00**

Replaced Old Famco No : FM100D01010

Oem Ref	Vehicle/Model	Engine
275608	F 10 N 10 NL 10/S N 10 Mark II	D 100 B TD 100 A/B/BG/G/GA FD 101 G/GA/USA TD 102/103

\* water pump repair kit with bearings (18 parts)

Remarks

to fit water pumps:

1699789	1545248	1698618
1699788	467915	1698619
1545427	467907	



WATER PUMP

**12.1050.00**

Replaced Old Famco No : FM101G11000

Oem Ref	Vehicle/Model	Engine
1545246	F 10	TD 101 G/GA
5002803		TD 102/103



Package Weight : **17,150 kg**  
 Package Dimensions : **23x35x22,5 cm**



**01.3105.00**  
 Ref : 467687



**01.3103.00**  
 Ref : 467575



**03.2103.00**  
 Ref : 421082



**03.3102.00**



**16.1022.00**

REPAIR KIT

**15.1022.00**

Replaced Old Famco No : FM100D11010

Oem Ref	Vehicle/Model	Engine
	F 10	D 100 B
	N 10v	TD 100 A/B/BG/G/GA
	NL 10/S	FD 101 G/GA/USA
	N 10 Mark II	TD 102/103

Remarks

to fit water pumps:

1699785 1545246  
 1698617 467906  
 1698615 422312

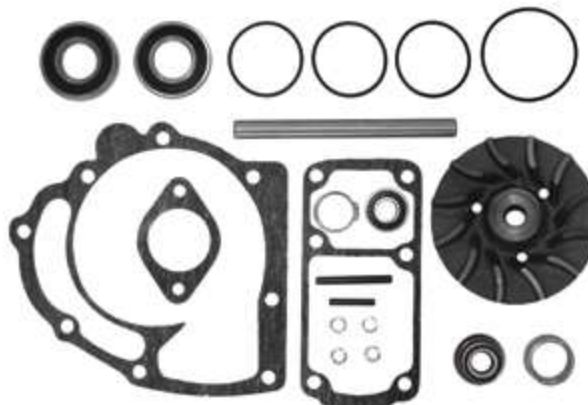

WATER PUMP

# 12.1032.00

Replaced Old Famco No : FM101D01000

Oem Ref	Vehicle/Model	Engine
1545248-1	F 10 - PERSIA	TD 101

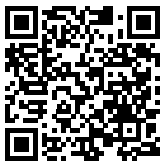

Package Weight : **17,400 kg**  
Package Dimensions : **23x35x22,5 cm**



**01.3107.00**



**03.2101.00**



**01.2103.00**



**09.4003.00**

REPAIR KIT

# 15.1032.00

Replaced Old Famco No : FM101D01010

Oem Ref	Vehicle/Model	Engine
	F 10 - PERSIA	TD 101



WATER PUMP

**12.1060.00**

Replaced Old Famco No : FM122D01000

Oem Ref	Vehicle/Model	Engine
422791	F 10	TD 102 F
5003351	F 12	TD 122 FK/FS



Package Weight : **12,400 kg**  
 Package Dimensions : **23x35x22,5 cm**



**03.6103.00**  
 Ref : 470265



**03.3101.00**  
 Ref : 468247



**03.2105.00**  
 Ref : 468249



**01.2105.00**  
 Ref : 8121826



**08.1104.00**  
 Ref : 1545358

REPAIR KIT

**15.1060.00**

Replaced Old Famco No : FM122D01010

Oem Ref	Vehicle/Model	Engine
	F 10	TD 102 F
	F 12	TD 122 FK/FS



WATER PUMP

# 12.1061.00

Replaced Old Famco No : FM122D11000

Oem Ref	Vehicle/Model	Engine
1699790	FL 10	TD 101/102/103
1698620	F 10	TD 121/122/123
1545261	CH 314 000→	TD 101/122/123
5002764	F 12	TD 101 EXCEPT
	CH 34 001→	TD 121/122
	N 10	TD 122
	CH 306 000→	
	N 12	
	CH 12 001→	
	NL 10	
	NL 12	
	B 12	



Package Weight : **12,300 kg**  
Package Dimensions : **23x35x22,5 cm**



**08.1103.00**  
Ref : 1545359



**09.5109.00**  
Ref : 423352



**09.5112.00**



**01.2107.00**  
Ref : 468244



**16.1060.00**

REPAIR KIT

# 15.1061.00

Replaced Old Famco No : FM122D11010

Oem Ref	Vehicle/Model	Engine
276802	FL 10	TD 101/102/103
276623	F 10	TD 121/122/123
275615	CH 314 000→	TD 101/122/123
	F 12	TD 101 EXCEPT
	CH 34 001→	TD 121/122
	N 10	TD 122
	CH 306 000→	
	N 12	
	CH 12 001→	
	NL 10	
	NL 12	
	B 12	



WATER PUMP

**12.1070.00**

Replaced Old Famco No : FM123D01000

Oem Ref	Vehicle/Model	Engine
20431484	F 10	TD 102/103 E
8113431	CH 314 000→	TD 103 ES
8113157	FL 10	TD 103
8112683	FS 10	TD 123 E/ES
8112523	F 12	
3184802	FL 12	
8149937	NL 12	
1675945	NL 12S	
479931	FM 10	
478845	FM 10BR	



Package Weight : **12,500 kg**  
 Package Dimensions : **23x35x22,5 cm**



**09.4001.00**  
 Ref : 1676561



**03.2107.00**  
 Ref : 1675947



**01.2104.00**  
 Ref : 1675944



**09.5111.00**  
 Ref : 423351

REPAIR KIT

**15.1070.00**

Replaced Old Famco No : FM123D01010

Oem Ref	Vehicle/Model	Engine
276936	F 10	TD 102/103 E
276814	CH 314 000→	TD 103 ES
	FL 10	TD 103
	FS 10	TD 123 E/ES
	F 12	
	FL 12	
	NL 12	
	NL 12S	
	FM 10	
	FM 10BR	



WATER PUMP

**12.1020.00**

Replaced Old Famco No : FMFH1601000

Oem Ref	Vehicle/Model	Engine
22197705	B 9 L	D 9
22902431	FH ENG - VE 16	D 13
22195450	FH ENG - VE 13	D 16
20744939	FH 16 RET - TH	
21468471	FH 16 URETARD	<b>Volvo Penta:</b>
21228793	FM ENG - VE 13	D 16C-A MG
20538845	VN ENG - VE 16	D 16C-A MG RC
21221878	VT ENG - VE 16	D 16C-A MH
20451516		TAD 1640 GE
3801418		TAD 1641 GE
3801102		TAD 1641 VE
		TAD 1642 GE
		TAD 1642 VE
		TAD 1643 VE
		TAD 1650 VE
		TWD 1643 GE

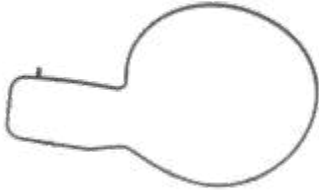

Package Weight : **2,800 kg**  
Package Dimensions : **22x32x14 cm**



**03.1601.00**



**09.2325.00**



**09.4002.00**  
Ref : 21014261



**06.1109.00**

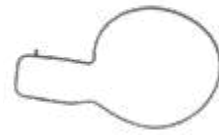

**09.5101.00**  
Ref : 21103569



**04.3101.00**  
Ref: 20707160  
21617479  
Diameter Ø148 mm

REPAIR KIT

**15.1020.00**

Replaced Old Famco No : FMFH1601010

Oem Ref	Vehicle/Model	Engine
	B 9 L	D 9
	FH ENG - VE 16	D 13
	FH ENG - VE 13	D 16
	FH 16 RET - TH	
	FH 16 URETARD	<b>Volvo Penta:</b>
	FM ENG - VE 13	D 16C-A MG
	VN ENG - VE 16	D 16C-A MG RC
	VT ENG - VE 16	D 16C-A MH
		TAD 1640 GE
		TAD 1641 GE
		TAD 1641 VE
		TAD 1642 GE
		TAD 1642 VE
		TAD 1643 VE
		TAD 1650 VE



WATER PUMP

**12.1040.00**

Replaced Old Famco No : FMFH1201000

Oem Ref	Vehicle/Model	Engine
8149941	FL10	D12A
8148460	FH12	(Manual Gear Box)
8113117	FL12	
1547155	NH12	
8112775		



Package Weight : **9,200 kg**  
 Package Dimensions : **21x31x18 cm**

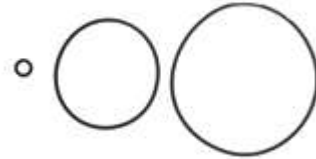

**03.6102.00**  
 Ref : 1547483



**03.3103.00**  
 Ref : 421549



**03.2105.00**  
 Ref : 468249



**09.2312.00**  
 Ref : 471499



**06.1102.00**  
 Ref : 3183676  
 1675638

REPAIR KIT

**15.1040.00**

Replaced Old Famco No : FMFH1201010

Oem Ref	Vehicle/Model	Engine
276121	FL10 FH12 FL12	D12A (Manual Gear Box)





WATER PUMP

**12.1130.00**

Replaced Old Famco No : FMFH1221000

Oem Ref	Vehicle/Model	Engine
8149882	B 12	D 12 A
1676713	FH 12	D 12 B
(8113155)	FL 12	
(8112889)		

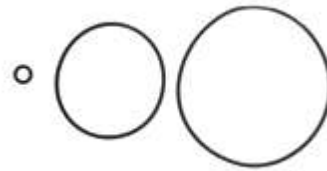

Package Weight : **9,300 kg**  
Package Dimensions : **21x31x18 cm**



**09.5113.00**  
Ref : 8170515  
(Metal Gasket)



**09.1101.00**  
Ref : 1676554



**09.1102.00**  
Ref : 8149943



**09.1104.00**



**16.1040.00**



**06.1103.00**  
Ref : 1676714

REPAIR KIT

**15.1130.00**

Replaced Old Famco No : FMFH1221010

Oem Ref	Vehicle/Model	Engine
276852	B 12	D 12 A
	FH 12	D 12 B
	FL 12	



WATER PUMP

**12.1120.00**

Replaced Old Famco No : FMFH1211000

Oem Ref	Vehicle/Model	Engine
8170305	B 12	D12C
8113274	B 12 R FH FH 12 FH 12 BR FM FM 12 FM 12 BR VHD VN	



Package Weight : **4,600 kg**  
 Package Dimensions : **17,5x18,5x16 cm**

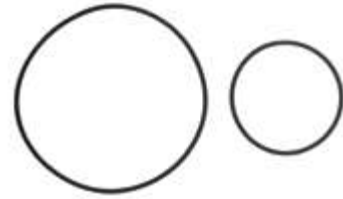

**03.6105.00**  
 Ref : 8170309



**09.2324.00**  
 Ref : 8170308



**09.4004.00**  
 Ref : 1676432



**06.1108.00**  
 Ref : 8170310

REPAIR KIT

**15.1120.00**

Replaced Old Famco No : FMFH1211010

Oem Ref	Vehicle/Model	Engine
	B 12 B 12 R FH FH 12 FH 12 BR FM FM 12 FM 12 BR VHD VN	D12C



WATER PUMP

**12.1140.00**

Replaced Old Famco No : FMFH1231000

Oem Ref	Vehicle/Model	Engine
20431135	NH 12	D12 C / D
20713787	NH 12 / (BR)	
20734268	FH	
8170833	FH12 / (BR)	
3803909	FM	
8113275	FM12 / (BR)	
85000452	B12 / (BR)	
	B12R	

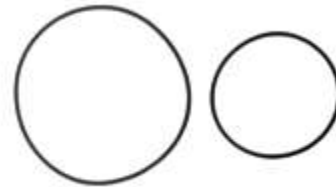

Package Weight : **4,600 kg**  
Package Dimensions : **17,5x18,5x16 cm**



**03.6105.00**  
Ref : 8170309



**09.2324.00**  
Ref : 8170308

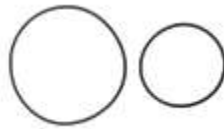

**16.1120.00**



**06.1107.00**  
Ref : 20431128

REPAIR KIT

**15.1140.00**

Replaced Old Famco No : FMFH1231010

Oem Ref	Vehicle/Model	Engine
	NH 12	D12C
	NH 12 BR	



WATER PUMP

**12.1010.00**

Replaced Old Famco No : FMFH1611000

Oem Ref	Vehicle/Model	Engine
3161436	FM	D 9
3803930	FM 9	
3803844		<b>Volvo Penta:</b>
3801484		D9A 2A MG
		TAD 940 GE
		TAD 940 VE
		TAD 941 GE
		TAD 941 VE
		TAD 943 VE
		TAD 950 VE
		TAD 951 VE
		TAD 952 VE

\*Pulley diameter  $\emptyset$  140 mm

Package Weight : **3,750 kg**  
 Package Dimensions : **21x31x18 cm**

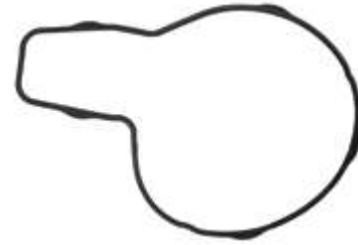
**02.1102.00**

Ref : 3161498

Diameter  $\emptyset$ 140 mm**09.2320.00**

Ref : 8148189

**09.4004.00**

Ref : 1676432

**06.1104.00**

Ref : 8131801

8170310

**09.1566.00**

Ref : 21415427

8131097

REPAIR KIT

**15.1010.00**

Replaced Old Famco No : FMFH1611010

Oem Ref	Vehicle/Model	Engine
	FM 9	B 9 L
		B 9 R
		B 9 S
		B 9 TL



WATER PUMP

**12.1210.00**

Replaced Old Famco No : FMFH1631000

Oem Ref	Vehicle/Model	Engine
21076088	B 9 L	D9A
20411880	B 9 R	D9B
(85000214)	B 9 S B 9 TL	

\*Pulley diameter Ø 168 mm



Package Weight : **4,150 kg**  
Package Dimensions : **21x31x18 cm**



**02.1103.00**  
Ref : 20411832  
Diameter Ø168 mm



**09.2320.00**  
Ref : 8148189



**09.4004.00**  
Ref : 1676432



**06.1104.00**  
Ref : 8131801  
8170310

REPAIR KIT

**15.1010.00**

Replaced Old Famco No : FMFH1611010

Oem Ref	Vehicle/Model	Engine
	FM 9	B 9 L B 9 R B 9 S B 9 TL



WATER PUMP

**10.1010.00**

Replaced Old Famco No : FMFH1613000

Oem Ref	Vehicle/Model	Engine
20464403	FM FM9 A25D / 4x4 A25E A30D A30E FB2800C FBR2800C G970 G976 G990 L150E	D9A D9B

\*Pulley diameter  $\emptyset$  140 mm

Package Weight : **8,600 kg**  
 Package Dimensions : **28x49x23 cm**



**09.1103.00**  
Ref : 3979940

**09.1105.00**

**09.1103.00**  
Ref : 3979940

**09.9916.00**  
Ref : 20430678

HOUSING

**11.1010.00**

Replaced Old Famco No : FMFH1612000

Oem Ref	Vehicle/Model	Engine
20431584	FM FM9 A25D / 4x4 A25E A30D A30E FB2800C FBR2800C G970 G976 G990 L150E	D9A D9B



Package Weight : **5,150 kg**  
 Package Dimensions : **27x49,5x15,5 cm**



WATER PUMP

**10.1020.00**

Replaced Old Famco No : FMFH1603000

Oem Ref	Vehicle/Model	Engine
20538820	FH	D 11 A / B / C
21469157	FM	D 13 A / B / C / F / H
21280077	PREVH	<b>Volvo Penta:</b> D 13 B
20995158	PREVX	
	A25F	
	EC340D	
	EC380D	
	EC480D	
	L150G	
	L180G	
	L220G	
	L250G	



Package Weight : **5,350 kg**  
Package Dimensions : **23x35x23 cm**

HOUSING

**11.1020.00**

Replaced Old Famco No : FMFH1602000

Oem Ref	Vehicle/Model	Engine
20505543	FH	D 11 A / B / C
22195464	FM	D 13 A / B / C / F / H
21284318	PREVH	<b>Volvo Penta:</b> D 13 B
(85003269)	PREVX	
(85020238)	A25F	
	EC340D	
	EC380D	
	EC480D	
	L150G	
	L180G	
	L220G	
	L250G	



Package Weight : **2,800 kg**  
Package Dimensions : **22x35x14 cm**

WATER PUMP

**10.1030.00**

Replaced Old Famco No : FMFH1643000



Oem Ref	Vehicle/Model	Engine
21296100	B 9 L B 9 R B 9 S B 9 TL	D9A D9B



Package Weight : **7,800 kg**  
Package Dimensions : **28x49x23 cm**

HOUSING

**11.1030.00**

Replaced Old Famco No : FMFH1642000



Oem Ref	Vehicle/Model	Engine
20539530 21295476	B 9 L B 9 R B 9 S B 9 TL	D9A D9B



Package Weight : **5,150 kg**  
Package Dimensions : **27x49,5x15,5 cm**



WATER PUMP

**12.1100.00**

Replaced Old Famco No : FMDH1201000

Oem Ref	Vehicle/Model	Engine
20879114	B 12 M	DH 12 C
20755669	B 12 B	DH 12 D
20592629		
20568564		
20548812		
1549491		
8113859		
85000476		
85000657		
85000412		
85000337		



Package Weight : **6,300 kg**  
Package Dimensions : **24x40x21 cm**



**03.1101.00**



**09.2324.00**



**06.1101.00**  
Ref : 1549485



**03.7101.00**



**08.1102.00**  
Ref : 20541466

REPAIR KIT

**15.1100.00**

Replaced Old Famco No : FMDH1201010

Oem Ref	Vehicle/Model	Engine
3096918	B 12 M B 12 B	DH 12 C DH 12 D



## WATER PUMP

**12.1090.00**

Replaced Old Famco No : FM63TD01000

Oem Ref	Vehicle/Model	Engine
8192050	B 6	TD 61
3183908	B 6 BLE	TD 63
477770	FL 6	D 6
477397	FL 608	TD 71
471500	FL 616	TD 73
465884	FL 7	D 7
420759	FM 7	
	FS 7	



Package Weight : **8,400 kg**  
 Package Dimensions : **21x31x18 cm**

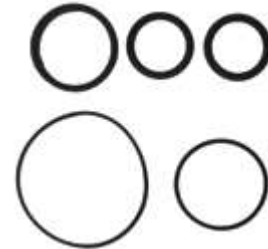

**03.6104.00**  
Ref : 471501



**09.2312.00**  
Ref : 471499



**03.3103.00**  
Ref : 421549



**03.2105.00**  
Ref : 468249



**06.1105.00**  
Ref : 1664823

## REPAIR KIT

**15.1090.00**

Replaced Old Famco No : FM63TD01010

Oem Ref	Vehicle/Model	Engine
276943	B 6	TD 61
276804	B 6 BLE	TD 63
	FL 6	D 6
	FL 608	TD 71
	FL 616	TD 73
	FL 7	D 7
	FM 7	
	FS 7	



WATER PUMP

**12.1091.00**

Replaced Old Famco No : FM63TD11000

Oem Ref	Vehicle/Model	Engine
20575653	B7 L	D7 A
3183909	B7 LDD	D7 B
(8113522)	B7 R	
(8112185)	FL7	
(85000387)	FM7	



Package Weight : **8,500 kg**  
Package Dimensions : **21x31x18 cm**

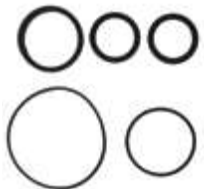

**16.1090.00**



**08.1105.00**  
Ref : 3183650



**08.1106.00**  
Ref : 471493



**08.1107.00**  
Ref : 471495



**06.1106.00**  
Ref : 20587287

REPAIR KIT

**15.1091.00**

Replaced Old Famco No : FM63TD11010

Oem Ref	Vehicle/Model	Engine
85107763	B7 L	D7 A
276942	B7 LDD	D7 B
276835	B7 R	
276803	FL7	
276054	FM7	
275624		



WATER PUMP

**12.1200.00**

Replaced Old Famco No : FMFH1621000

Oem Ref	Vehicle/Model	Engine
8149980	F 16	D 16 A / B
1543380	FH 16	TD 162 F
1556330	L 330 C	TD 163 E
1543960	L 330 C LL	
1543480	L 330 D	
(8113116)	L 330 E	

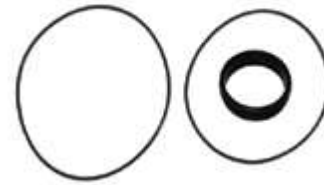

Package Weight : **10,800 kg**  
 Package Dimensions : **21x26x27 cm**



**03.6101.00**  
 Ref : 1543452



**03.2106.00**  
 Ref : 1675920



**09.1551.00**  
 Ref : 1556397



**09.5155.00**  
 Ref : 1556412  
 (CRNI wire ring)



**01.2106.00**  
 Ref : 1556331



**03.1102.00**  
 Ref : 1543891

REPAIR KIT

**15.1200.00**

Replaced Old Famco No : FMFH1621010

Oem Ref	Vehicle/Model	Engine
276637	F 16	D 16 A / B
276636	FH 16	TD 162 F
	L 330 C	TD 163 E
	L 330 C LL	
	L 330 D	
	L 330 E	

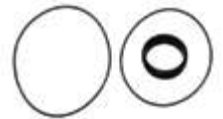

**16.1200.00**



WATER PUMP

**12.6140.00**

Replaced Old Famco No : FM053001000

Oem Ref	Vehicle/Model	Engine
20834409	D5 E	TAD 530 GE
20997647	D5 F	TAD 531 GE
21417491	D7 E	TAD 532 GE
85009894	FE	TAD 560 VE
85003894	FL	TAD 561 VE
3801244	B5LH	TAD 562 VE
3801164	B5RH	TAD 563 VE
	B6R	TAD 564 VE
	B7R	TAD 565 VE
	DE	TAD 720 GE
		TAD 730 GE
		TAD 731 GE

\*with metal gasket



Package Weight : **4,350 kg**  
Package Dimensions : **27x27x16 cm**



**02.1101.00**



**09.2342.00**



**09.5104.00**  
Ref : 21632658  
20793735  
(Metal Gasket)



**01.2102.00**



**09.1561.00**  
Ref : 21364517  
20799907

REPAIR KIT

**15.6140.00**

Replaced Old Famco No : FM053001010

Oem Ref	Vehicle/Model	Engine
	D5 E	TAD 530 GE
	D5 F	TAD 531 GE
	D7 E	TAD 532 GE
	FE	TAD 560 VE
	FL	TAD 561 VE
	B5LH	TAD 562 VE
	B5RH	TAD 563 VE
	B6R	TAD 564 VE
	B7R	TAD 565 VE
	DE	TAD 720 GE
		TAD 730 GE
		TAD 731 GE

\*with metal gasket



WATER PUMP

**12.6150.00**

Replaced Old Famco No : FM053021000

Oem Ref	Vehicle/Model	Engine
D5 E		TAD 530 GE
D5 F		TAD 531 GE
D7 E		TAD 532 GE
FE		TAD 560 VE
FL		TAD 561 VE
B5LH		TAD 562 VE
B5RH		TAD 563 VE
B6R		TAD 564 VE
B7R		TAD 565 VE
DE		TAD 720 GE
		TAD 730 GE
		TAD 731 GE

*\*with metal gasket kit*

Package Weight : **4,600 kg**  
 Package Dimensions : **27x27x16 cm**

**02.1101.00****09.2342.00****09.4002.00**  
Ref : 21014261**01.2102.00****09.1561.00**  
Ref : 21364517  
20799907

GASKET KIT

**16.6140.00**

Replaced Old Famco No : FM053001009

Oem Ref	Vehicle/Model	Engine
D5 E		TAD 530 GE
D5 F		TAD 531 GE
D7 E		TAD 532 GE
FE		TAD 560 VE
FL		TAD 561 VE
B5LH		TAD 562 VE
B5RH		TAD 563 VE
B6R		TAD 564 VE
B7R		TAD 565 VE
DE		TAD 720 GE
		TAD 730 GE
		TAD 731 GE

*\*with metal gasket*

WATER PUMP

**12.1080.00**

Replaced Old Famco No : FM42D001000

Oem Ref	Vehicle/Model	Engine
787186		D 42 4300



Package Weight : **8,300 kg**  
Package Dimensions : **21x31x18 cm**



**01.3106.00**



**03.2102.00**  
Ref : 1170195



**16.1080.00**  
Ref : 785612



**01.2101.00**  
Ref : 1676432



**09.1559.00**  
Ref : 785556

REPAIR KIT

**15.1080.00**

Replaced Old Famco No : FM42D001010

Oem Ref	Vehicle/Model	Engine
11701095	D 42 A	D 42
754569	D 45 B	4300



WATER PUMP

**12.6090.00**

Replaced Old Famco No : FM046011000

Oem Ref	Vehicle/Model	Engine
21974080	FM (4)	D 11 C
21969187		D 11 K
21812242		Euro 5
21648712		
20921947		

\*Pulley diameter  $\emptyset$  148 mm



Package Weight : **6,150 kg**  
 Package Dimensions : **21x31x18 cm**

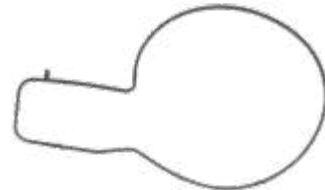

WATER PUMP

**12.6030.00**

Replaced Old Famco No : FM046021000

Oem Ref	Vehicle/Model	Engine
21960479	FH	D 13 C
21969183	FH (4)	D 13 K
21814009	FM	Euro 5
21648708	FM (4)	
21030340		
20920085		
(85013466)		
(85013056)		
(85000956)		

\*Pulley diameter  $\emptyset$  155 mm



Package Weight : **6,200 kg**  
 Package Dimensions : **21x31x18 cm**

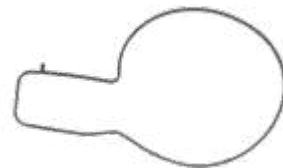



WATER PUMP

**12.6040.00**

Replaced Old Famco No : FM046031000

Oem Ref	Vehicle/Model	Engine
21960481	FH	D 13 C / K
21814005	FH (4)	Euro 6
21648711	FM	
20920065	FM (4)	
(85013057)		
(85000957)		

\*Pulley diameter  $\emptyset$  124 mm



Package Weight : **5,550 kg**  
Package Dimensions : **21x31x18 cm**



WATER PUMP

**10.6030.00**

Replaced Old Famco No : FM046023000

Oem Ref	Vehicle/Model	Engine
21941086	FH	D 13 C
21648908	FH (4)	Euro 5
	FM	
	FM (4)	

\*Pulley diameter  $\emptyset$  155 mm



Package Weight : **8,650 kg**  
Package Dimensions : **23x35x23 cm**



WATER PUMP

**10.6040.00**

Replaced Old Famco No : FM046033000

Oem Ref	Vehicle/Model	Engine
21648910	FH FH (4) FM FM (4)	D 13 C / K Euro 5

\*Pulley diameter  $\varnothing$  124 mm



Package Weight : **7,850 kg**  
Package Dimensions : **23x35x23 cm**



**09.1101.00**  
Ref : 1676554



**09.1105.00**

HOUSING

**11.1040.00**

Replaced Old Famco No : FMFH1232000

Oem Ref	Vehicle/Model	Engine
20713789 8170312	NH 12 NH 12 BR B 12 B 12 R FH FH 12 FH 12 BR FM FM 12 FM 12 BR VHD VN	D12C

Remarks

to fit water pumps:  
20431135 8170305  
20713787 8170833  
20734268

Package Weight : **8,600 kg**  
Package Dimensions : **28x28x24 cm**



WATER PUMP

**12.1260.00**

Replaced Old Famco No :

Oem Ref	Vehicle/Model	Engine
23154956	B5LH 2008 - B5	TAD851
22107715	B5LH 2011 - 7900	D13C
23552770	B8R 2013 - 8900	D13K
23552788	B8R 2013 - 9500	TAD570-72VE
22951346	B8R 2013 - B8	TAD540-42VE
21735265	FE III 2013 - FE 250	TAD550-51VE
3801893	FE III 2013 - FE 280	TAD552VE
3801552	FE III 2013 - FE 320	TAD570-71VE-B
85021610	FL3 2013 - FL 250	TAD580-83VE
85021779	FL3 2013 - FL 280	TAD870-73VE
85022484	FL 6 (2000-)	TAD840-43VE
85027610		TAD850-52VE
85028484		TAD853VE
		TAD880-84VE
		TAD840GE
		TAD880-82GE
		TAD841-43GE
		TAD851-53GE

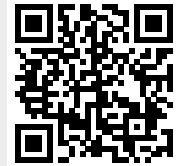

Package Weight : **9,200 kg**  
Package Dimensions : **23x35x23 cm**



**01.2109.00**



**03.1103.00**



**03.2110.00**



**03.4103.00**



**09.5175.00**  
Ref : 21795852

WATER PUMP

**10.6040.51**

Replaced Old Famco No :

Oem Ref	Vehicle/Model	Engine
Fit for the below Oem Ref:	FH FH (4) FM FM (4)	D 13 C / K Euro 5
21648910		

\*Pulley diameter  $\emptyset$  124 mm



Package Weight : **7,850 kg**  
Package Dimensions : **23x35x23 cm**



WATER PUMP

# 12.6090.51

Replaced Old Famco No :

Oem Ref	Vehicle/Model	Engine
Fit for the below Oem Ref:	FM (4)	D 11 C D 11 K Euro 5
21974080		
21969187		
21812242		
21648712		
20921947		

\*Pulley diameter  $\varnothing$  148 mm



Package Weight : **6,150 kg**  
Package Dimensions : **21x31x18 cm**

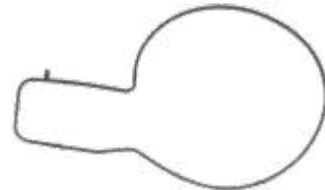

WATER PUMP

# 12.6030.51

Replaced Old Famco No :

Oem Ref	Vehicle/Model	Engine
Fit for the below Oem Ref:	FH FH (4) FM FM (4)	D 13 C D 13 K Euro 5
21960479		
21969183		
21814009		
21648708		
21030340		
20920085		
(85013466)		
(85013056)		
(85000956)		

\*Pulley diameter  $\varnothing$  155 mm



Package Weight : **6,200 kg**  
Package Dimensions : **21x31x18 cm**



WATER PUMP

## 12.6040.51

Replaced Old Famco No :

Oem Ref	Vehicle/Model	Engine
Fit for the below Oem Ref:	FH FH (4) FM FM (4)	D 13 C / K Euro 6
21960481		
21814005		
21648711		
20920065		
(85013057)		
(85000957)		

\*Pulley diameter  $\emptyset$  124 mm



Package Weight : **5,550 kg**  
Package Dimensions : **21x31x18 cm**



WATER PUMP

## 10.6030.51

Replaced Old Famco No :

Oem Ref	Vehicle/Model	Engine
Fit for the below Oem Ref:	FH FH (4) FM FM (4)	D 13 C Euro 5
21941086		
21648908		

\*Pulley diameter  $\emptyset$  155 mm



Package Weight : **8,650 kg**  
Package Dimensions : **23x35x23 cm**



VOLVO

SCANIA

MERCEDES-BENZ

MAN

DAF

RENAULT

IVECO

OTHERS

FOR SCANIA



[www.famco.com.tr](http://www.famco.com.tr)



WATER PUMP

**12.2030.00**

Replaced Old Famco No : FM124G01000

Oem Ref	Vehicle/Model	Engine
1896752	114G	D 9 / 11 / 12
1508533	124 C/G/L	DC 9 19 / 20 / 21
1353072	P-, G-, R-, T LKW	D 11 / 12
(570962)	4 LKW, 4 BUS	DSC 11 74 / 75 / 79
(570955)	4 LKW	D 12 A
(570951)		D 12 M
		DC 12 MOXY
		DI 12 49 A

\*impeller: ø 105 mm  
blade: 17 mm



Package Weight : **3,600 kg**  
Package Dimensions : **22,5x24,5x16 cm**

HOUSING

**11.2030.00**

Replaced Old Famco No : FM124G02000

Oem Ref	Vehicle/Model	Engine
1450153	4 Truck	D9
1376495	P-, G-, R-, T	D11
	Truck	D12
	4 Bus	DC9
	P96 Industrial /	DC12A
	Marine	Moxy



Package Weight : **1,850 kg**  
Package Dimensions : **25,5x28x7,5 cm**

REPAIR KIT

**15.2030.00**

Replaced Old Famco No : FM124G01010

Oem Ref	Vehicle/Model	Engine
551355	114G	D 9 / 11 / 12
552127	124 C/G/L	DC 9 19 / 20 / 21
552107	P-, G-, R-, T LKW	D 11 / 12
	4 LKW, 4 BUS	DSC 11 74 / 75 / 79
	4 LKW	D 12 A
		D 12 M
		DC 12 MOXY
		DI 12 49 A



**01.2201.00**  
Ref : 1460083



WATER PUMP

**12.2060.00**

Replaced Old Famco No : FM144G01000

Oem Ref	Vehicle/Model	Engine
1508532	144G	DSC 14
1508534	144L	D14
1365841	4LKW	

(570966)  
(570956)  
(570952)



Package Weight : **3,550 kg**  
Package Dimensions : **22,5x24,5x16 cm**



**02.1201.00**  
Ref : 1781673  
1413135



**09.2319.00**  
Ref : 1382541  
750153



**09.1597.00**  
Ref : 1403883



**01.2205.00**



**16.2060.00**



**09.5116.00**

REPAIR KIT

**15.2060.00**

Replaced Old Famco No : FM144G01010

Oem Ref	Vehicle/Model	Engine
551369	144G	DSC 14
552129	144L	D14
552126	4LKW	
552109		
552106		





WATER PUMP

**12.2010.00**

Replaced Old Famco No : FM124R01000

Oem Ref	Vehicle/Model	Engine
1789522	124R	D 9 PDE
1546188	144R	D 11
1533783	P-, G-, R-, T 4 LKW, 4 Bus	D 12 DC 9 19 / 20 / 21 D 11 / 12
(570965)	F-, K-, N Bus	DC 12 MOXY
(570964)		DC 12 57 A
(570959)		SG 9 A 280 DC 9 A EMS

\*impeller: ø 112 mm  
blade: 21 mm



Package Weight : **3,650 kg**  
Package Dimensions : **22,5x24,5x16 cm**



**02.1204.00**  
Ref : 1779993  
1529076



**09.2322.00**  
Ref : 1528923



**01.2204.00**  
Ref : 1534248

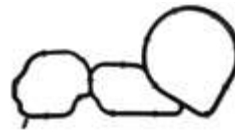

**09.1539.00**  
Ref : 1879484  
1549027



**09.5118.00**  
Ref : 1541633

REPAIR KIT

**15.2010.00**

Replaced Old Famco No : FM124R01010

Oem Ref	Vehicle/Model	Engine
GENERAL OVERHAUL KIT	124R 144R P-, G-, R-, T 4 LKW, 4 Bus F-, K-, N Bus	D 9 PDE D 11 D 12 DC 9 19 / 20 / 21 D 11 / 12 DC 12 MOXY DC 12 57 A SG 9 A 280 DC 9 A EMS

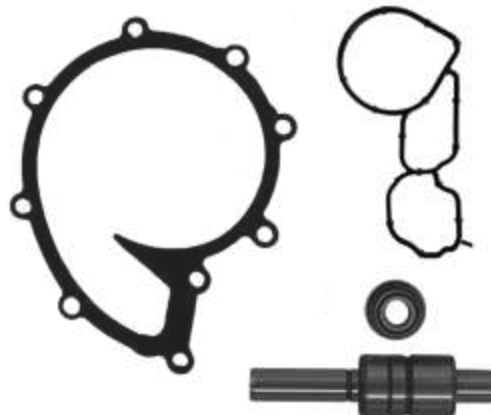

WATER PUMP

**10.2010.00**

Replaced Old Famco No : FM124R03000



Package Weight : **5,150 kg**  
 Package Dimensions : **24,5x28,5x14,5 cm**



HOUSING

**11.2010.00**

Replaced Old Famco No : FM124R02000



Package Weight : **1,70 kg**  
 Package Dimensions : **25,5x28x7,5 cm**

Oem Ref	Vehicle/Model	Engine
1787121	124R	D 9 PDE
1528348	144R	D 11
	P-, G-, R-, T	D 12
	4 LKW, 4 Bus	DC 9 19 / 20 / 21
	F-, K-, N Bus	D 11 / 12
		DC 12 MOXY
		DC 12 57 A
		SG 9 A 280
		DC 9 A EMS

WATER PUMP

**12.2071.00**

Replaced Old Famco No : FM480R11000

Oem Ref	Vehicle/Model	Engine
2006397	P-, G-, R-, T	D 13
2224112	F-, K-, N	D 9 XPI
2224147	E 2011	DC 09 / 13A
576662		DI 13M

\*impeller: ø 120 mm



Package Weight : **4,750 kg**  
Package Dimensions : **24,5x28,5x14,5 cm**



**02.1202.00**  
Ref : 2006207



**09.2335.00**



**09.4002.00**



**06.1201.00**  
Ref : 2006209

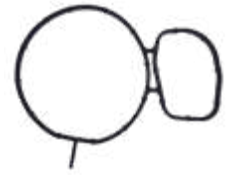

**09.1541.00**  
Ref : 1886594  
1782197

REPAIR KIT

**15.2071.00**

Replaced Old Famco No : FM480R11010

Oem Ref	Vehicle/Model	Engine
	P-, G-, R-, T	D 13
	F-, K-, N	D 9 XPI
	E 2011	DC 09 / 13A
		DI 13M



WATER PUMP

**12.2070.00**

Replaced Old Famco No : FM480R01000

Oem Ref	Vehicle/Model	Engine
1884327	P-, G-, R-, T	D 13
2224045	F-, K-, N	D 9 XPI
1789555	E 2011	DC 09 / 13A
1778923		DI 13M
1939481		
2034084		
(576663)		
(570193)		
(570194)		

\*impeller: ø 113 mm



Package Weight : **5,200 kg**  
 Package Dimensions : **24,5x28,5x14,5 cm**



**02.1203.00**  
 Ref : 1793651



**09.2322.00**  
 Ref : 1528923



**09.4003.00**  
 Ref : 1435069



**01.2206.00**  
 Ref : 1884336



**09.5120.00**  
 Ref : 1778922

REPAIR KIT

**15.2070.00**

Replaced Old Famco No : FM480R01010

Oem Ref	Vehicle/Model	Engine
	P-, G-, R-, T	D 13
	F-, K-, N	D 9 XPI
	E 2011	DC 09 / 13A
		DI 13M



WATER PUMP

**10.2080.00**

Replaced Old Famco No :

Oem Ref	Vehicle/Model	Engine
2363452	L-/P-/G-/R-/S-Series	DC 16 XPI
2142744	P-/G-/R-/T-Series	DC 16
2113389		
1945069		
571244		
571149		



Package Weight : **6,800 kg**  
Package Dimensions : **28x40x18 cm**

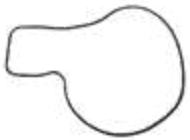
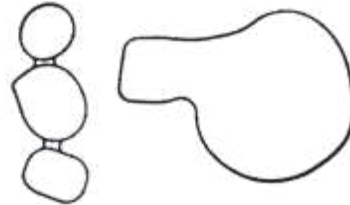

**09.1599.00**  
Ref : 1886664



**09.1598.00**  
Ref : 1886663



**16.2080.00**



**02.1205.00**  
Ref : 2006202



**06.1202.00**  
Ref : 2363382

HOUSING

**11.2080.00**

Replaced Old Famco No :

Oem Ref	Vehicle/Model	Engine
2212472	L-/P-/G-/R-/S-Series	DC 16 XPI
	P-/G-/R-/T-Series	DC 16



Package Weight : **2,250 kg**  
Package Dimensions : **26x45x7,5 cm**



WATER PUMP

**12.2020.00**

Replaced Old Famco No : FM620R01000

Oem Ref	Vehicle/Model	Engine
1549482	P-, G-, R-, T	D 16 PDE
1546491	P 96 4 LKW	D 16M D 16A D 16
(570958)		
(570954)		



Package Weight : **3,800 kg**  
 Package Dimensions : **22x35,5x14 cm**



**02.1204.00**  
 Ref : 1779993  
 1529076

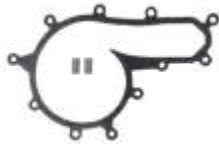

**16.2022.00**  
 Ref : 1498650



**09.5121.00**  
 Ref : 1427261



**01.2204.00**  
 Ref : 1534248

REPAIR KIT

**15.2020.00**

Replaced Old Famco No : FM620R01010

Oem Ref	Vehicle/Model	Engine
	P-, G-, R-, T	D 16 PDE
	P 96	D 16M
	4 LKW	D 16A D 16



WATER PUMP

**10.2020.00**

Replaced Old Famco No : FM620R03000

Oem Ref	Vehicle/Model	Engine
1793989	P-, G-, R-, T	D 16 PDE
1549481	P 96	D 16M
1510404	4 LKW	D 16A
1433792		D 16
(570881)		
(570958)		
(570954)		



Package Weight : **6,350 kg**  
Package Dimensions : **28x49,5x15,5 cm**

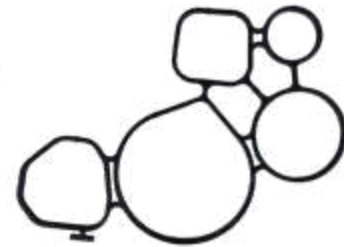
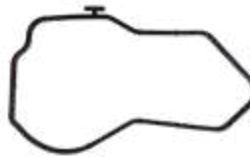

**09.1542.00**  
Ref : 1464464

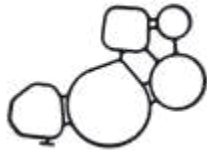

**09.1552.00**  
Ref : 1457411

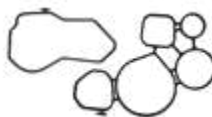

**16.2020.00**

HOUSING

**11.2020.00**

Replaced Old Famco No : FM620R02000

Oem Ref	Vehicle/Model	Engine
1793990	P-, G-, R-, T	D 16
1429397	P 96	D16 A
	4 LKW	D 16 PDE
		D 16 M



Package Weight : **2,750 kg**  
Package Dimensions : **56x45x7 cm**



WATER PUMP

**12.2040.00**

Replaced Old Famco No : FM094001000

Oem Ref	Vehicle/Model	Engine
1510490	4 LKW	D 9
1486098	4 BUS	D 9 A
1380897	4 Industrie / Schiff- fahrt	D 9 M
		DI9 53
		DI9 56
(570961)		DC9 51
(570957)		K 94
(570953)		L 94
(571157)		N 94
		SG 9 A 280
		SIG 12 A



Package Weight : **2,250 kg**  
 Package Dimensions : **17,5x18,5x16 cm**



**03.1201.00**  
 Ref : 1486102



**09.2319.00**  
 Ref : 1382541



**09.4003.00**  
 Ref : 1435069



**01.2207.00**  
 Ref : 1380902

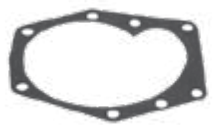

**09.5122.00**  
 Ref : 1384468

REPAIR KIT

**15.2040.00**

Replaced Old Famco No : FM094001010

Oem Ref	Vehicle/Model	Engine
550269	4 LKW	D 9
	4 BUS	D 9 A
	4 Industrie / Schiff- fahrt	D 9 M
		DI9 53
		DI9 56
		DC9 51
		K 94
		L 94
		N 94
		SG 9 A 280
		SIG 12 A





WATER PUMP

**12.2011.00**

Replaced Old Famco No : FM011101000

Oem Ref	Vehicle/Model	Engine
259065 (571055)	3 BUS	N113 D 11 DS11



Package Weight : **8,050 kg**  
Package Dimensions : **21x25x21 cm**



**03.2201.00**  
Ref : 228834



**01.2202.00**  
Ref : 372310



**09.5114.00**  
Ref : 231795



**09.5119.00**



**16.2011.00**

REPAIR KIT

**15.2011.00**

Replaced Old Famco No : FM011001010

Oem Ref	Vehicle/Model	Engine
550044	3 BUS	N113 D 11 DS11

**15.2022.00**

Replaced Old Famco No : FM011101010

Oem Ref	Vehicle/Model	Engine
550142	111 3 BUS	N113 D 11 DS11



WATER PUMP

**12.2021.00**

Replaced Old Famco No : FM011201000

Oem Ref	Vehicle/Model	Engine
1314406	3 BUS	CP / CR / CT 113
292761	3 TRUCK	D 11 A
(575100)		D 11 M
(571059)		F 113
		K 113
		L 113



Package Weight : **8,200 kg**  
 Package Dimensions : **21x26x27 cm**



**03.2202.00**  
 Ref : 278338



**16.2021.00**



**09.5114.00**  
 Ref : 231795



**09.5115.00**  
 Ref : 292759



**01.2202.00**  
 Ref : 372310

REPAIR KIT

**15.2011.00**

Replaced Old Famco No : FM011001010

Oem Ref	Vehicle/Model	Engine
550044	3 BUS	N113
		D 11
		DS11

**15.2021.00**

Replaced Old Famco No : FM011201010

Oem Ref	Vehicle/Model	Engine
550167	3 BUS	CP / CR / CT 113
	3 TRUCK	GR / GRS 900 R
		CP 113



WATER PUMP

**12.2031.00**

Replaced Old Famco No : FM011301000

Oem Ref	Vehicle/Model	Engine
1354103 571150	3 BUS 3 TRUCK	CP / CR / CT 113 GR / GRS 900 R CP 113 GA 850 ALLISON HD4060 P K 113 GR 801 R ZFHP

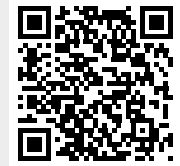

Package Weight : **8,150 kg**  
Package Dimensions : **21x26x27 cm**



**03.2202.00**  
Ref : 278338



**01.2203.00**  
Ref : 270181



**09.5114.00**  
Ref : 231795



**09.5115.00**  
Ref : 292759



**09.4012.00**  
Ref : 363143 (A)  
311438 (B)

REPAIR KIT

**15.2031.00**

Replaced Old Famco No : FM011301010

Oem Ref	Vehicle/Model	Engine
550168	3 BUS 3 TRUCK	CP / CR / CT 113 GR / GRS 900 R CP 113 GA 850

**15.2021.00**

Replaced Old Famco No : FM011201010

Oem Ref	Vehicle/Model	Engine
550167	3 BUS 3 TRUCK	CP / CR / CT 113 GR / GRS 900 R CP 113 GA 850



FUEL FEED PUMP

**32.2010.00**

Replaced Old Famco No :

Oem Ref	Vehicle/Model	Engine
1518142	4 Truck	D12
1440235	P-, G-, R-, T Truck	DC12
1436301	F-, K-, N Bus	DT12



Package Weight : **4,200 kg**  
 Package Dimensions : **17,5x18,5x16 cm**



FUEL FEED PUMP

**32.2020.00**

Replaced Old Famco No :

Oem Ref	Vehicle/Model	Engine
2059884	P, G, R, T-Series	DC13
2894842	K, N, F- Series Bus	



Package Weight : **3,600 kg**  
 Package Dimensions : **13x15x14 cm**



OIL PUMP

## 22.2010.00

Replaced Old Famco No :

Oem Ref	Vehicle/Model	Engine
2209509	4 Truck	D11
2028987	P-, G-, R-, T Truck	D12
1888025		D12K
1448659	4 Bus	DC11
1345719	F-, K-, N Bus	DC12
	P96 Industrial / Marine	DC12A
		DI12



Package Weight : **4,100 kg**  
Package Dimensions : **21x31x18 cm**

OIL PUMP

## 22.2020.00

Replaced Old Famco No :

Oem Ref	Vehicle/Model	Engine
2686288	<b>Scania Trucks</b>	DC13
2105497	P, G, R, T Series	OC13
1860961	L, P, G, R Series	D13, K13
1730312	<b>Scania Bus</b>	
	F, K, N Series	
	C, K Series	



Package Weight : **4,750 kg**  
Package Dimensions : **21x31x18 cm**

VOLVO

SCANIA

MERCEDES-BENZ

MAN

DAF

RENAULT

IVECO

OTHERS

FOR MERCEDES-BENZ



[www.famco.com.tr](http://www.famco.com.tr)



WATER PUMP

**12.3230.00**

Replaced Old Famco No : FM262201000

Oem Ref	Vehicle/Model	Engine
4032007101		OM 401 A
4032005101		OM 402/A
4032004401		OM 403
		OM 404 A
		OM 407/A/AH/H/HA/LA
		OM 421/ A/LA
		OM 422/ A/LA
		OM 423/ A/LA...

\*impeller: ø 125 mm width: 12 mm



Package Weight : **11,600 kg**  
Package Dimensions : **24x40x16 cm**



**03.1403.00**  
Ref : 4032020414



**09.2328.00**  
Ref : 4032001802



**09.4004.00**  
Ref : 0012011919



**01.2305.00**  
Ref : 4032011307  
Ø 125x15 12 mm



**16.3230.00**

REPAIR KIT

**15.3230.00**

Replaced Old Famco No : FM260001010

Oem Ref	Vehicle/Model	Engine
4222000604	F 10	OM 401 A
4222000104	N 10v	OM 402/A
4222000304	NL 10/S	OM 403
4232000104	N 10 Mark II	OM 404 A
4232000004		OM 407/A/AH/H/HA/LA
		OM 421/ A/LA
		OM 422/ A/LA
		OM 423/ A/LA
		OM 424/ A/LA
		OM 427/ A/H/HA/LA
		OM OM/ 441/ A/LA
		OM 442/ A/LA
		OM 443
		OM 444
		OM 447/A/H/HA/LA

\*impeller: ø 125 mm width: 12 mm

Remarks

to fit water pumps:  
403 200 4401 403 200 7101  
403 200 5101  
403 200 7601  
403 200 7701

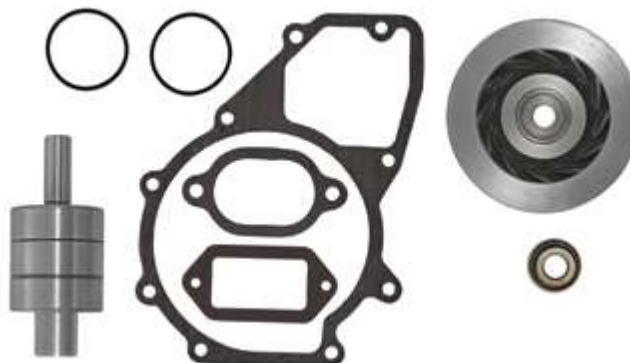

WATER PUMP

**12.3340.00**

Replaced Old Famco No : FM042311000

Oem Ref	Vehicle/Model	Engine
4222001001		OM 423/ A/LA
4222000501		OM 443 LA OM 444

\*impeller:  $\varnothing$  135 mm (closed)

Package Weight : **11,750 kg**  
 Package Dimensions : **24x40x16 cm**



**03.1403.00**  
 Ref : 4032020414



**09.2328.00**  
 Ref : 4032001902



**09.5137.00**  
 Ref : 4032010480  
 4422010480



**01.2307.00**  
 Ref : 4222010207  
 $\varnothing$ 135x15 mm (closed)



**09.5134.00**  
 Ref : 4032011080  
 4422010080

REPAIR KIT

**15.3250.00**

Replaced Old Famco No : FM042301010

Oem Ref	Vehicle/Model	Engine
4222000504		OM 401/A
4222000404		OM 402/A
4222000204		OM 403
4222000004		OM 407/A/AH/H/HA/LA
		OM 421/A/LA
		OM 422/A/LA
		OM 423/A/LA
		OM 424/A/LA
		OM 427/A/H/HA/LA
		OM 441/A/LA
		OM 422/A/LA
		OM 443
		OM 444
		OM 447/A/H/HA/LA

\*impeller:  $\varnothing$  135 mm (closed)Remarks

to fit water pumps:

422 200 1001  
 422 200 0501  
 422 200 1401  
 422 200 1301





WATER PUMP

**12.3231.00**

Replaced Old Famco No : FM262211000

Oem Ref	Vehicle/Model	Engine
4032007701		OM 401/A
4032007601		OM 402/A
		OM 403
		OM 407/A/AH/H/HA/LA
		OM 421/A/LA
		OM 422/A/LA
		OM 423/A/LA
		OM 424/A/LA
		OM 427/A/H/HA/LA
		OM 441/A/LA
		OM 422/A/LA...

\*impeller: ø 125 mm width: 12 mm



Package Weight : **11,650 kg**  
Package Dimensions : **24x40x16 cm**



**03.1403.00**  
Ref : 4032020414



**09.2328.00**  
Ref : 4032001902



**09.4004.00**  
Ref : 0012012619



**01.2305.00**  
Ref : 4032011307  
Ø125x15 12 mm



**09.5136.00**  
Ref : 4422010380

GASKET SET

**16.3250.00**

Replaced Old Famco No :

Oem Ref	Vehicle/Model	Engine
4032006901		
4032000260		



WATER PUMP

**12.3250.00**

Replaced Old Famco No : FM042301000

Oem Ref	Vehicle/Model	Engine
4222001401		OM 423 LA
4222001301		OM 443 LA

\*impeller:  $\varnothing$  135 mm (closed)

Package Weight : **11,650 kg**  
 Package Dimensions : **24x40x16 cm**

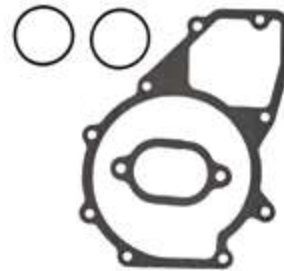

**03.1403.00**  
 Ref : 4032020414



**09.2328.00**  
 Ref : 4032001902



**09.4004.00**  
 Ref : 0012012619



**01.2307.00**  
 Ref : 4222010207  
 $\varnothing$  135 x 15 mm (closed)

REPAIR KIT

**15.3250.00**

Replaced Old Famco No : FM042301010

Oem Ref	Vehicle/Model	Engine
4222000504		OM 401/A
4222000404		OM 402/A
4222000204		OM 403
4222000004		OM 407/A/AH/H/HA/LA
		OM 421/A/LA
		OM 422/A/LA
		OM 423/A/LA
		OM 424/A/LA
		OM 427/A/H/HA/LA
		OM 441/A/LA
		OM 422/A/LA
		OM 443
		OM 444
		OM 447/A/H/HA/LA

\*impeller:  $\varnothing$  135 mm (closed)Remarks

to fit water pumps:

422 200 1001  
 422 200 0501  
 422 200 1401  
 422 200 1301



WATER PUMP

**12.3270.00**

Replaced Old Famco No : FM262231000

Oem Ref	Vehicle/Model	Engine
4412000201	441.900	OM 441
4412000101	441.920	OM 441
	440.907, 909	OM 442
	442.900, 905	OM 442
	442.920	OM 442

\*impeller: ø 125 mm width: 8 mm



Package Weight : **11,650 kg**  
Package Dimensions : **24x40x16 cm**



**03.1403.00**  
Ref : 4032020414



**09.2328.00**  
Ref : 4032001902



**09.4004.00**  
Ref : 0012012619



**01.2304.00**  
Ref : 4412010207  
Ø 125x15 8 mm

REPAIR KIT

**15.3260.00**

Replaced Old Famco No : FM260021010

Oem Ref	Vehicle/Model	Engine
	441.900 – 919	OM 441
	from engine: 504520	OM 441
	441.920 – 933	OM 442
	from engine: 504520	OM 442
	440.907, 909	OM 442
	442.900, 905 – 919	OM 442
	from engine: 504398	OM 442
	442.920 – 939	OM 442
	from engine: 504398	OM 442

\*impeller: ø 125 mm width: 8 mm

Remarks

to fit water pumps:

- 441 200 0301
- 441 200 0201
- 441 200 0101

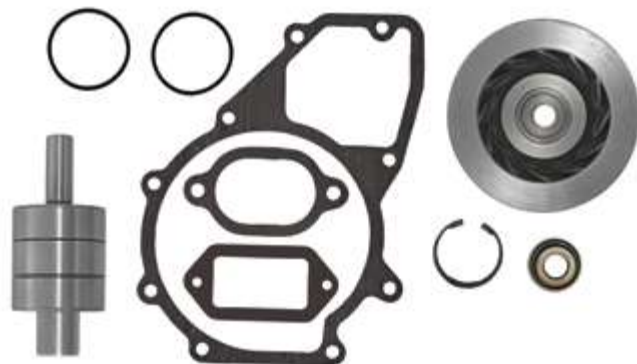

WATER PUMP

**12.3070.00**

Replaced Old Famco No : FM184001000

Oem Ref	Vehicle/Model	Engine
4572002301	AXOR	OM 457
4572000801		OM 458

\*impeller:  $\varnothing$  125 mm width: 8 mm

Package Weight : **11,700 kg**  
 Package Dimensions : **24x40x16 cm**

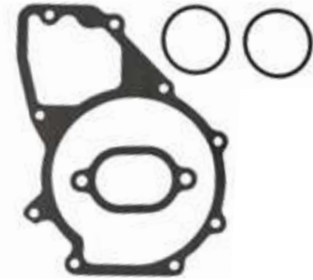

**03.1403.00**  
 Ref : 5422020114



**09.2328.00**  
 Ref : 0002000002  
 4422000102



**09.5128.00**  
 Ref : 4572010080  
 (Paper Gasket)



**01.2304.00**  
 Ref : 4412010207  
 $\varnothing$  125x15 8mm



**16.3080.00**

REPAIR KIT

**15.3070.00**

Replaced Old Famco No : FM184001010

Oem Ref	Vehicle/Model	Engine
4412000204	AXOR	OM 457
4412000104		OM 458
4572000004		

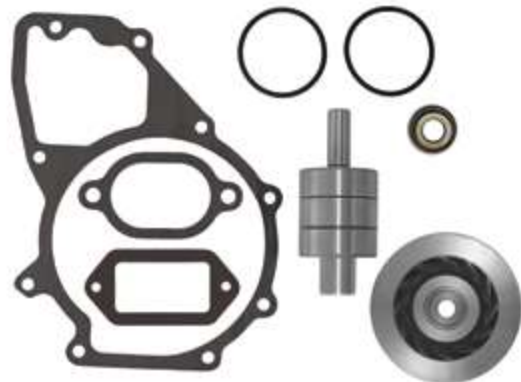
\*impeller:  $\varnothing$  125 mm width: 8 mm

WATER PUMP

**12.3100.00**

Replaced Old Famco No : FM184041000

Oem Ref	Vehicle/Model	Engine
4572002901	AXOR	OM 457 OM 458

\*impeller: ø 125 mm width: 8 mm

\*with metal gasket



Package Weight : **11,760 kg**  
Package Dimensions : **24x40x16 cm**

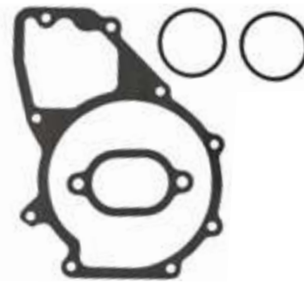

**03.1403.00**  
Ref : 5422020114



**09.2328.00**  
Ref : 0002000002  
4422000102



**09.5129.00**  
Ref : 4572010380  
(Metal Gasket)



**01.2304.00**  
Ref : 4412010207  
Ø 125x15 8 mm

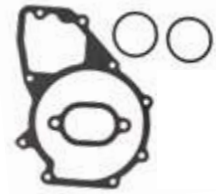

**16.3100.00**  
(Metal Gasket)

GASKET KIT

**16.3070.00**

Replaced Old Famco No : FM184001009

Oem Ref	Vehicle/Model	Engine
4572000401		
4572000301		

\*with metal gasket



WATER PUMP

**12.3260.00**

Replaced Old Famco No : FM262241000

Oem Ref	Vehicle/Model	Engine
4412000301	441.900 – 919 from engine: 504520 442.900, 905 – 919 from engine: 504398	OM 440 OM 441 OM442

\*impeller:  $\varnothing$  125 mm width: 8 mm

Package Weight : **11,600 kg**  
Package Dimensions : **24x40x16 cm**



**03.1403.00**  
Ref : 5422020114



**09.2328.00**  
Ref : 0002000002  
4422000102



**09.4004.00**  
Ref : 0012012619



**01.2304.00**  
Ref : 4412010207  
 $\varnothing$  125x15 8 mm

REPAIR KIT

**15.3260.00**

Replaced Old Famco No : FM260021010

Oem Ref	Vehicle/Model	Engine
	441.900 – 919 from engine: 504520 441.920 – 933 from engine: 504520 440.907, 909 442.900, 905 – 919 from engine: 504398 442.920 – 939 from engine: 504398	OM 441 OM 441 OM 442 OM 442 OM 442

\*impeller:  $\varnothing$  125 mm width: 8 mmRemarks

to fit water pumps:

441 200 0301  
441 200 0201  
441 200 0101

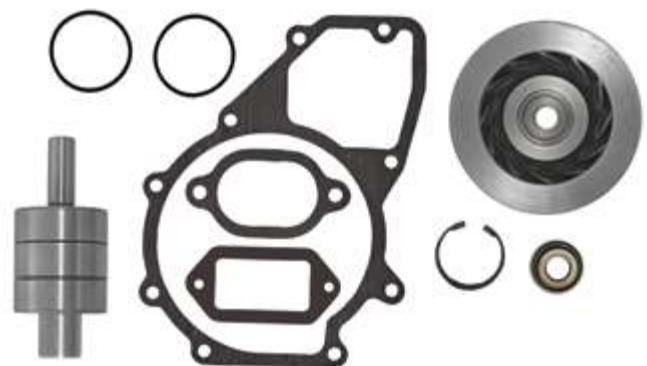

WATER PUMP

**12.3150.00**

Replaced Old Famco No : FM184821000

Oem Ref	Vehicle/Model	Engine
5422002201	ACTROS	OM 502 LA
5422001801	420kW 542.924 448kW 542.956	

\*impeller: ø 125 mm width: 12 mm



Package Weight : **15,100 kg**  
Package Dimensions : **24x40x21 cm**



**02.2302.00**



**09.2329.00**



**09.5135.00**  
Ref : 5412010280  
9425010080



**01.2305.00**  
Ref : 5422010007  
Ø 125x15 12mm



**16.3141.00**

REPAIR KIT

**15.3150.00**

Replaced Old Famco No : FM184821010

Oem Ref	Vehicle/Model	Engine
	ACTROS	OM 502 LA
	420kW 542.924 448kW 542.956	

\*impeller: ø 125 mm width: 12 mm

Remarks

to fit water pumps:

5422002201  
5422001801  
5422002601



WATER PUMP

**12.3071.00**

Replaced Old Famco No : FM184011000

Oem Ref	Vehicle/Model	Engine
4572000101	AXOR	OM 457 LA
4752000201	265kW 457.925	OM 458 LA
4752000101	320kW 457.922	
4572001601		

\*impeller:  $\varnothing$  125 mm width: 12 mm

Package Weight : **11,700 kg**  
 Package Dimensions : **24x40x16 cm**

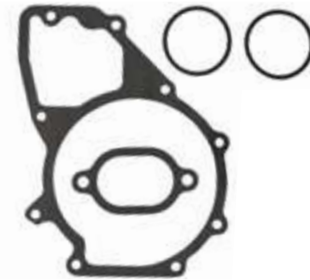

**03.1403.00**  
 Ref : 5422020114



**09.2328.00**  
 Ref : 0002000002  
 4422000102



**09.4004.00**  
 Ref : 0012012619



**01.2305.00**  
 Ref : 4032011307  
 $\varnothing$  125x15 12mm

REPAIR KIT

**16.3071.00**

Replaced Old Famco No :

Oem Ref	Vehicle/Model	Engine
4222000060		
4222000901		





WATER PUMP

**12.3130.00**

Replaced Old Famco No : FM184071000

Oem Ref	Vehicle/Model	Engine
4602003001		OM 457 LA - 457.937
4602002801		OM 457 LA - 457.939
4572000601		OM 457 LA - 457.943 OM 457 LA - 458.910

\*impeller: ø 125 mm width: 12 mm

\*with metal gasket



Package Weight : **12,000 kg**  
Package Dimensions : **24x40x16 cm**

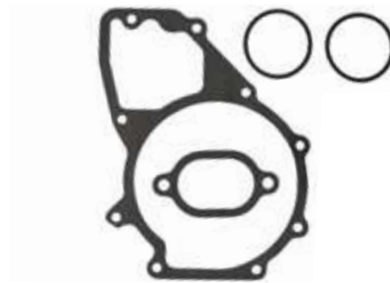

**03.1403.00**  
Ref : 5422020114



**09.2328.00**  
Ref : 0002000002  
4422000102



**09.4004.00**  
Ref : 0012012619



**01.2305.00**  
Ref : 4032011307  
Ø 125x15 12mm



**09.5129.00**  
Ref : 4572010380  
(Metal Gasket)

REPAIR KIT

**15.3080.00**

Replaced Old Famco No : FM184021010

Oem Ref	Vehicle/Model	Engine
4572000104	AXOR	OM 457 OM 458

\*impeller: ø 125 mm width: 12 mm

\*with metal gasket



WATER PUMP

**12.3170.00**

Replaced Old Famco No : FM184841000

Oem Ref	Vehicle/Model	Engine
5422002101	ACTROS	OM 501 LA OM 502 LA
	541.920, 926	
	541.940, 941	
	541.951	
	541.922, 927	
	941.920	
	541.942, 943	
	541.923, 924	
	941.981	
	541.944, 945	
	541.921, 925	
	941.990	
	541.946, 947	
	541.948	

\*impeller: ø 125 mm width: 12 mm



Package Weight : **14,550 kg**  
 Package Dimensions : **24x40x21 cm**

**02.2302.00****09.2329.00**

**09.4004.00**  
 Ref : 0012012619



**01.2305.00**  
 Ref : 5422010007  
 Ø 125x15 12mm

**16.3170.00**

REPAIR KIT

**15.3170.00**

Replaced Old Famco No : FM184841010

Oem Ref	Vehicle/Model	Engine
	ACTROS	OM 502 LA
	420kW 542.924	
	448kW 542.956	

\*impeller: ø 125 mm width:12 mm



WATER PUMP

**12.3072.00**

Replaced Old Famco No : FM184801000

Oem Ref	Vehicle/Model	Engine
5412001201	ACTROS	OM 501 LA
5412001101	315kW 521.940	
5412000101	230kW 541.920	
	315kW 541.921	
	260kW 541.922	
	290kW 541.923	
	315kW 541.925	
	355kW 541.948	
	230kW 941.910	
	290kW 941.929	
	300kW 941.930	
	230kW 941.960	
	290kW 941.980	
	315kW 941.990	

\*impeller: ø 125 mm width: 8 mm



Package Weight : **12,300 kg**  
Package Dimensions : **24x40x16 cm**



**03.1403.00**  
Ref : 5422020114



**09.2328.00**  
Ref : 4422000102



**09.4004.00**  
Ref : 0012012619



**01.2304.00**  
Ref : 4412010207  
Ø 125x15 8mm

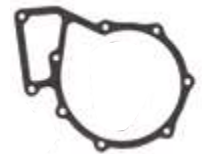

**09.5124.00**  
Ref : 5422010080  
(Paper Gasket)

REPAIR KIT

**15.3072.00**

Replaced Old Famco No : FM180001010

Oem Ref	Vehicle/Model	Engine
5412000004	ACTROS	OM 501 LA
	315kW 521.940	
	230kW 541.920	
	315kW 541.921	
	260kW 541.922	
	290kW 541.923	
	315kW 541.925	
	355kW 541.948	
	230kW 941.910	

\*impeller: ø 125 mm width: 8 mm

Remarks

to fit water pumps:  
5412001201 5412001401  
5412001101  
5412000101



WATER PUMP

**12.3160.00**

Replaced Old Famco No : FM184831000

Oem Ref	Vehicle/Model	Engine
5422001901	ACTROS	OM 501 LA
5422001501	315kW 521.940	OM 502 LA
5422000501	230kW 541.920	
	315kW 541.921	
	260kW 541.922	
	290kW 541.923	
	315kW 541.925	
	355kW 541.948	
	230kW 941.910	
	290kW 941.929	
	300kW 941.930	
	230kW 941.960	
	290kW 941.980	
315kW 941.990		

\*impeller: ø 125 mm width: 12 mm



Package Weight : **11,950 kg**  
 Package Dimensions : **24x40x16 cm**



**03.1403.00**  
 Ref : 5422020114



**09.2328.00**  
 Ref : 4422000102



**09.4004.00**  
 Ref : 0012012619



**01.2305.00**  
 Ref : 5422010007  
 Ø 125x15 12mm

GASKET KIT

**16.3180.00**

Replaced Old Famco No : FM180001009

Oem Ref	Vehicle/Model	Engine
5422000701		

\* with metal gasket

Remarks

to fit water pumps:  
 542 200 1901 542 200 2001  
 542 200 1501 542 200 1601  
 542 200 0501 542 200 0601  
 542 200 2401



WATER PUMP

**12.3141.00**

Replaced Old Famco No : FM184811000

Oem Ref	Vehicle/Model	Engine
5422002001	ACTROS	OM 501 LA
5422001601	With Retarder	OM 502 A
5422000601		
5412001001		

\*impeller: ø 125 mm width: 12 mm



Package Weight : **12,650 kg**  
Package Dimensions : **24x40x16 cm**



**03.1403.00**  
Ref : 5422020114



**09.2328.00**  
Ref : 4422000102



**09.4004.00**  
Ref : 0012012619



**01.2305.00**  
Ref : 5422010007  
Ø 125x15 12mm

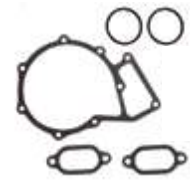

**16.3141.00**

REPAIR KIT

**15.3141.00**

Replaced Old Famco No : FM180011010

Oem Ref	Vehicle/Model	Engine
5422000004	ACTROS	OM 501 LA
	315kW 521.940	OM 502 LA
	230kW 541.920	
	315kW 541.921	
	260kW 541.922	
	290kW 541.923	
	315kW 541.925	
	355kW 541.948	
	230kW 941.910	

\*impeller: ø 125 mm width: 12 mm

Remarks

to fit water pumps:  
542 200 1901 542 200 2001  
542 200 1501 542 200 1601  
542 200 0501 542 200 0601



WATER PUMP

**12.3010.00**

Replaced Old Famco No : FM151701000

Oem Ref	Vehicle/Model	Engine
9042004901	ATEGO	OM 904 LA
9042002601		OM 906 LA/HLA/LAG
9042000801		OM 924 LA
9042000401		
9042004301		
9042003801		
9042003201		
9042002201		
9042002001		
9042001901		
9042000701		
9042000201		
9042002501		



Package Weight : **10,400 kg**  
 Package Dimensions : **24x40x16 cm**



**03.1301.00**  
 Ref : 9042020014



**09.2328.00**  
 Ref : 4422000102



**09.9002.00**  
 Ref : 9062030015



**09.4004.00**  
 Ref : 0012012619



**01.2302.00**  
 Ref : 9062010007

REPAIR KIT

**15.3010.00**

Replaced Old Famco No : FM151701010

Oem Ref	Vehicle/Model	Engine
9042000004	ATEGO	OM 904 LA
9062000004		OM 906 LA/HLA/LAG
9042000204		OM 924 LA



WATER PUMP

**12.3030.00**

Replaced Old Famco No : FM151731000

Oem Ref	Vehicle/Model	Engine
9042005101		OM 904 LA - 900.911
9042004701		OM 904 LA - 900.912 OM 904 LA - 900.913 OM 904 LA - 900.915

\*with two threads M14x1.5



Package Weight : **10,400 kg**  
Package Dimensions : **24x40x16 cm**



**03.1301.00**  
Ref : 9042020014



**09.5162.00**  
Ref : 9062030176



**09.5127.00**  
Ref : 9062030180



**16.3030.00**



**09.5126.00**  
Ref : 9062010080

GASKET KIT

**16.3010.00**

Replaced Old Famco No : FM151701009

Oem Ref	Vehicle/Model	Engine
9042001201	ATEGO	OM 904 LA
9042001101		OM 906 LA/HLA/LAG
9062001001		OM 924 LA
9042000501		



WATER PUMP

**12.3280.00**

Replaced Old Famco No : FM151761000

Oem Ref	Vehicle/Model	Engine
9042005001		OM 904 LA
9042004601		OM 906 LA
9042002901		OM 924 LA
9042002701		
9042002401		



Package Weight : **10,600 kg**  
 Package Dimensions : **24x40x16 cm**

**03.1303.00****09.2315.00****03.2302.00****09.9002.00**  
Ref : 9062030415**01.2302.00**  
Ref : 9062010007

REPAIR KIT

**15.3280.00**

Replaced Old Famco No : FM151761010

Oem Ref	Vehicle/Model	Engine
9042000404		OM 904 LA OM 906 LA OM 924 LA





WATER PUMP

**12.3300.00**

Replaced Old Famco No : FM151781000

Oem Ref	Vehicle/Model	Engine
9042005301		OM 904 LA



Package Weight : **10,600 kg**  
Package Dimensions : **24x40x16 cm**



**03.1303.00**



**09.2315.00**



**03.2302.00**



**09.9002.00**  
Ref : 9062030615



**01.2302.00**  
Ref : 9062010007

REPAIR KIT

**15.3280.00**

Replaced Old Famco No : FM151761010

Oem Ref	Vehicle/Model	Engine
9042000404		OM 904 LA OM 906 LA OM 924 LA



WATER PUMP

**12.3080.00**

Replaced Old Famco No : FM184021000

Oem Ref	Vehicle/Model	Engine
4572002501	AXOR	OM 457
4572000501	Back Side	OM 458
4572000201	Hole 20 mm	

\*impeller:  $\varnothing$  125 mm width: 12 mm

Package Weight : **12,250 kg**  
 Package Dimensions : **24x40x16 cm**



**03.1403.00**  
 Ref : 5422020114



**09.2328.00**  
 Ref : 4032001802



**09.4004.00**  
 Ref : 0012012619



**01.2305.00**  
 Ref : 4032011307  
 $\varnothing$  125x15 12mm



**16.4180.00**

REPAIR KIT

**15.3071.00**

Replaced Old Famco No : FM184011010

Oem Ref	Vehicle/Model	Engine
	AXOR	OM 457 LA
	265kW 457.925	OM 458 LA
	320kW 457.922	

\*impeller:  $\varnothing$  125 mm width: 12 mm

WATER PUMP

**12.3110.00**

Replaced Old Famco No : FM184051000

Oem Ref	Vehicle/Model	Engine
4572002701	AXOR Back Side Hole 20 mm	OM 457 OM 458

\*impeller: ø 125 mm width: 12 mm

\*with metal gasket



Package Weight : **12,400 kg**  
Package Dimensions : **24x40x16 cm**



**03.1403.00**  
Ref : 5422020114



**09.2328.00**  
Ref : 4032001802



**09.5136.00**  
Ref : 4422010380



**01.2305.00**  
Ref : 4032011307  
Ø 125x15 12mm



**16.3110.00**  
(Metal Gasket)

REPAIR KIT

**15.3080.00**

Replaced Old Famco No : FM184021010

Oem Ref	Vehicle/Model	Engine
4572000104	AXOR	OM 457 OM 458

\*impeller: ø 125 mm width: 12 mm

\*with metal gasket



WATER PUMP

**12.3220.00**

Replaced Old Famco No : FM251701000

Oem Ref	Vehicle/Model	Engine
3662005901	366.901	OM 366
3662000901	366.941	OM 366A
3662000401	366.970	OM 366LA
	357.930	OM 366LA EURO II

\*without cover



Package Weight : **6,450 kg**  
 Package Dimensions : **21x31x18 cm**



**02.2301.00**  
 Ref : 3522010039



**03.2303.00**  
 Ref : 3662010205



**06.1301.00**  
 Ref : 3662000204



**09.5161.00**  
 Ref : 3662010180



**09.5133.00**  
 Ref : 3642010280



**16.3220.00**

REPAIR KIT

**15.3220.00**

Replaced Old Famco No : FM251701010

Oem Ref	Vehicle/Model	Engine
3662000804	366.901	OM 366
3662000604	366.941	OM 366A
3662000304	366.970	OM 366LA
3662000004	357.930	OM 366LA EURO II



WATER PUMP

**12.3240.00**

Replaced Old Famco No : FM262221000

Oem Ref	Vehicle/Model	Engine
4032007301	O 303	OM 402 LA EURO I
4032005301	O 330	OM 407/H/A/LA/HA
4032004701	O 305 G	OM 427 A/LA/HA
	O 405	OM 427/H
		OM 441A/LA
		OM 447 HLA EURO II
		OM 447 A/LA/HA

\*impeller: ø 125 mm width: 12 mm



Package Weight : **12,350 kg**  
Package Dimensions : **24x40x16 cm**



**03.1403.00**  
Ref : 4032020414



**09.2328.00**  
Ref : 4032001802



**09.4004.00**  
Ref : 0012012619



**01.2305.00**  
Ref : 4032011307  
Ø 125x15 12mm

REPAIR KIT

**15.3230.00**

Replaced Old Famco No : FM260001010

Oem Ref	Vehicle/Model	Engine
4222000604	F 10	OM 401 A
4222000104	N 10v	OM 402/A
4222000304	NL 10/S	OM 403
4232000104	N 10 Mark II	OM 404 A
4232000004		OM 407/A/AH/H/HA/LA
		OM 421/ A/LA
		OM 422/ A/LA
		OM 423/ A/LA
		OM 424/ A/LA
		OM 427/ A/H/HA/LA
		OM OM/ 441/ A/LA
		OM 442/ A/LA
		OM 443
		OM 444
		OM 447/A/H/HA/LA

\*impeller: ø 125 mm width: 12 mm

Remarks  
to fit water pumps:  
403 200 4401 403 200 7101  
403 200 5101  
403 200 7601  
403 200 7701

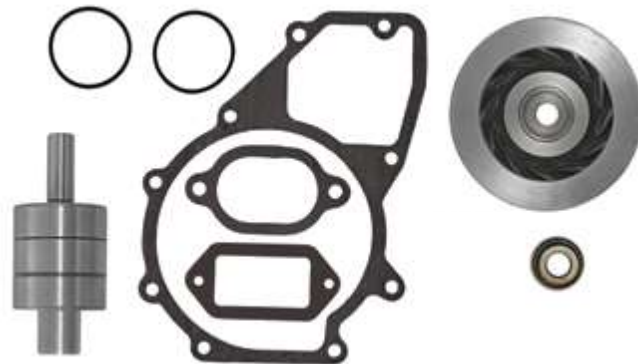

WATER PUMP

**12.3090.00**

Replaced Old Famco No : FM184031000

Oem Ref	Vehicle/Model	Engine
4572002401	AXOR	OM 457
4572001801	Back Side	OM 458
4572001001	Hole Closed	
4572000901		

\*impeller:  $\varnothing$  125 mm width: 12 mm

Package Weight : **12,500 kg**  
 Package Dimensions : **24x40x16 cm**



**03.1403.00**  
 Ref : 4032020414



**09.2328.00**  
 Ref : 4032001802



**09.4004.00**  
 Ref : 0012012619



**01.2305.00**  
 Ref : 4032011307  
 $\varnothing$  125x15 12mm

REPAIR KIT

**15.3071.00**

Replaced Old Famco No : FM184011010

Oem Ref	Vehicle/Model	Engine
	AXOR	OM 457 LA
	265kW 457.925	OM 458 LA
	320kW 457.922	

\*impeller:  $\varnothing$  125 mm width:12 mm

WATER PUMP

**12.3120.00**

Replaced Old Famco No : FM184061000

Oem Ref	Vehicle/Model	Engine
4572002801		OM 457 LA - 457.907 OM 457 LA - 457.908 OM 457 LA - 457.909 OM 457 LA - 457.915

\*impeller: ø 125 mm width: 12 mm

\*with metal gasket



Package Weight : **12,500 kg**  
Package Dimensions : **24x40x16 cm**



**03.1403.00**  
Ref : 4032020414



**09.2328.00**  
Ref : 4032001802



**09.4004.00**  
Ref : 0012012619



**01.2305.00**  
Ref : 4032011307  
Ø 125x15 12mm

REPAIR KIT

**15.3080.00**

Replaced Old Famco No : FM184021010

Oem Ref	Vehicle/Model	Engine
4572000104	AXOR	OM 457 OM 458

\*impeller: ø 125 mm width: 12 mm

\*with metal gasket



WATER PUMP

**12.3020.00**

Replaced Old Famco No : FM042321000

Oem Ref	Vehicle/Model	Engine
4222001101		OM 401 / A
4222000601		OM 402 / A
4222001601		OM 403
4222001801		OM 407 / A / AH / H / HA / LA
		OM 421 / A / LA
		OM 422 / A / LA
		OM 423 / A / LA
		OM 424 / A / LA
		OM 427 / A / H / HA / LA...

\*impeller:  $\varnothing$  135 mm

Package Weight : **12,450 kg**  
 Package Dimensions : **24x40x16 cm**



**03.1403.00**  
 Ref : 4032020414



**09.2328.00**  
 Ref : 4032001802



**09.4004.00**  
 Ref : 0012012619



**01.2306.00**  
 $\varnothing$  135 mm

REPAIR KIT

**15.3251.00**

Replaced Old Famco No :

Oem Ref	Vehicle/Model	Engine
		OM 401 / A
		OM 402 / A
		OM 403
		OM 407 / A / AH / H / HA / LA
		OM 421 / A / LA
		OM 422 / A / LA
		OM 423 / A / LA
		OM 424 / A / LA
		OM 427 / A / H / HA / LA
		OM 441 / A / LA
		OM 442 / A / LA
		OM 443
		OM 444
		OM 447 / A / H / HA / LA

\*impeller:  $\varnothing$  135 mm



WATER PUMP

**12.3180.00**

Replaced Old Famco No : FM184851000

Oem Ref	Vehicle/Model	Engine
5412001401	ACTROS	OM 501 LA
	315kW 521.940	
	230kW 541.920	1831 – 3331
	315kW 541.921	1843 – 3343
	260kW 541.922	
	290kW 541.923	
	315kW 541.925	
	355kW 541.948	
	230kW 941.910	
	290kW 941.929	
	300kW 941.930	
	230kW 941.960	
	290kW 941.980	
	315kW 941.990	

\*impeller: ø 125 mm width: 8 mm

\*with metal gasket



Package Weight : **12,500 kg**  
Package Dimensions : **24x40x16 cm**



**03.1403.00**  
Ref : 4032020414



**09.2328.00**  
Ref : 4032001802



**09.5125.00**  
Ref : 5422010180  
(Metal Gasket)



**01.2304.00**  
Ref : 4412010207  
Ø 125x15 8 mm



**09.1527.00**  
Ref : 0249972848



**16.3181.00**  
(Metal Gasket)

REPAIR KIT

**15.3180.00**

Replaced Old Famco No : FM180031010

Oem Ref	Vehicle/Model	Engine
	ACTROS	OM 501 LA
	315kW 521.940	
	230kW 541.920	
	315kW 541.921	
	260kW 541.922	
	290kW 541.923	
	315kW 541.925	

\*impeller: ø 125 mm width: 8 mm

\*with metal gasket

Remarks

to fit water pumps:  
5412001201 5412001401  
5412001101  
5412000101



WATER PUMP

**12.3181.00**

Replaced Old Famco No :

Oem Ref	Vehicle/Model	Engine
5422002301	ACTROS	OM 501 LA
	315kW 521.940	
	230kW 541.920	1831 – 3331
	315kW 541.921	1843 – 3343
	260kW 541.922	
	290kW 541.923	
	315kW 541.925	
	355kW 541.948	
	230kW 941.910	
	290kW 941.929	
	300kW 941.930	
	230kW 941.960	
	290kW 941.980	
	315kW 941.990	

\*impeller:  $\varnothing$  125 mm width: 12 mm

\*with metal gasket



Package Weight : **12,500 kg**  
 Package Dimensions : **24x40x16 cm**



**03.1403.00**  
 Ref : 4032020414



**09.2328.00**  
 Ref : 4032001802



**09.5125.00**  
 Ref : 5422010180  
 (Metal Gasket)



**01.2305.00**  
 Ref : 5422010007  
 $\varnothing$  125x15 12mm



**09.1527.00**  
 Ref : 0249972848



**16.3181.00**  
 (Metal Gasket)

REPAIR KIT

**15.3181.00**

Replaced Old Famco No : FM180031010

Oem Ref	Vehicle/Model	Engine
	ACTROS	OM 501 LA
	315kW 521.940	
	230kW 541.920	
	315kW 541.921	
	260kW 541.922	
	290kW 541.923	
	315kW 541.925	

\*impeller:  $\varnothing$  125 mm width: 12 mm

\*with metal gasket

Remarks

to fit water pumps:  
 5412001201 5412001401  
 5412001101  
 5412000101



WATER PUMP

**12.3190.00**

Replaced Old Famco No : FM184861000

Oem Ref	Vehicle/Model	Engine
5422002401	ACTROS With Retarder	OM 501 LA OM 502 A
	230 kW	541.920
	315 kW	541.921
	260 kW	541.922
	290 kW	541.923, 924
	315 kW	541.925
	230 kW	541.926
	260 kW	541.927
	230 kW	541.940, 941
	260 kW	541.942, 943
	290 kW	541.944, 945
	315 kW	541.946, 947
	355 kW	541.948

\*impeller: ø 125 mm width: 12 mm

\*with metal gasket



Package Weight : **11,600 kg**  
Package Dimensions : **24x40x16 cm**



**03.1403.00**  
Ref : 4032020414



**09.2328.00**  
Ref : 4032001802



**09.4004.00**  
Ref : 0012012619



**01.2305.00**  
Ref : 5422010007  
Ø 125x15 12mm



**16.3190.00**  
(Metal Gasket)

REPAIR KIT

**15.3190.00**

Replaced Old Famco No : FM180021010

Oem Ref	Vehicle/Model	Engine
5422000104	ACTROS	OM 501 LA OM 502 LA
	315kW	521.940
	230kW	541.920
	315kW	541.921
	260kW	541.922

\*impeller: ø 125 mm width: 12 mm

\*with metal gasket

Remarks

to fit water pumps:

- 542 200 1901 542 200 2001
- 542 200 1501 542 200 1601
- 542 200 0501 542 200 0601
- 542 200 2401



WATER PUMP

**12.3011.00**

Replaced Old Famco No : FM151711000

Oem Ref	Vehicle/Model	Engine
9062006101		OM 904 LA
9062006701		OM 906 LA / HLA
		OM 924 LA
		OM 926 LA
		M 906 LAG



Package Weight : **10,750 kg**  
 Package Dimensions : **24x40x16 cm**

**03.1303.00**

**09.2315.00**  
 Ref : 4149810205

**03.2302.00**

**09.9002.00**  
 Ref : 9062030615



**01.2303.00**  
 Ref : 9062010107

REPAIR KIT

**15.3011.00**

Replaced Old Famco No : FM151711010

Oem Ref	Vehicle/Model	Engine
9062000304		OM 904 LA
		OM 906 LA / HLA
		OM 924 LA
		OM 926 LA
		M 906 LAG

Remarks

to fit water pumps:

906 200 6101	906 200 3801	906 200 1401	906 200 3701
906 200 6501	906 200 2901	906 200 1301	906 200 2601
906 200 5701	906 200 2801	906 200 0901	906 200 6201
906 200 5401	906 200 2201	906 200 5501	



WATER PUMP

**12.3290.00**

Replaced Old Famco No : FM151771000

Oem Ref	Vehicle/Model	Engine
9062006401		OM 904 LA - 904.925
9062004801		OM 904 LA - 904.945
9062004201		OM 904 LA - 904.962
9062003201		OM 904 LA - 904.965
9062002401		
9062001801		



Package Weight : **10,500 kg**  
Package Dimensions : **24x40x16 cm**



**03.1301.00**



**09.2328.00**  
Ref : 4032001802



**09.9002.00**  
Ref : 9062030615



**09.4004.00**  
Ref : 0012012619



**01.2303.00**  
Ref : 9062010107

REPAIR KIT

**15.3290.00**

Replaced Old Famco No : FM151771010

Oem Ref	Vehicle/Model	Engine
9062000204		
9062000104		



WATER PUMP

**12.3040.00**

Replaced Old Famco No : FM151741000

Oem Ref	Vehicle/Model	Engine
9062006501		OM 904 LA - 904.925
9062005801		OM 904 LA - 904.928
9062005701		OM 904 LA - 904.932
9062005401		OM 904 LA - 904.945
9062003801		
9062002901		
9062002201		
9062001401		
9062001301		
9062000901		



Package Weight : **10,750 kg**  
 Package Dimensions : **24x40x16 cm**

**03.1303.00**

**09.2315.00**  
 Ref : 4149810205

**03.2302.00**

**09.9002.00**  
 Ref : 9062030615



**01.2303.00**  
 Ref : 9062010107

GASKET KIT

**16.3010.00**

Replaced Old Famco No : FM151701009

Oem Ref	Vehicle/Model	Engine
9042001201	ATEGO	OM 904 LA
9042001101		OM 906 LA/HLA/LAG
9062001001		OM 924 LA
9042000501		



WATER PUMP

**12.3060.00**

Replaced Old Famco No : FM151791000

Oem Ref	Vehicle/Model	Engine
9062006201		OM 904 LA -904.915
9062005501		OM 904 LA -904.932
9062003701		OM 904 LA -904.939
9062002801		OM 904 LA -904.940
9062002801		OM 904 LA -904.946
9062004901		OM 904 LA -904.947
		OM 904 LA -904.954
		OM 904 LA -904.956
		OM 904 LA -904.971
		OM 904 LA -904.975
		OM 906 LA -902.970
		OM 906 LA -906.911
		OM 906 LA -906.915
		OM 906 LA -906.929
		OM 906 LA -906.932
		OM 906 LA -906.933
		OM 906 LA -906.944
		OM 906 LA -906.945
		OM 906 LA -906.946
		OM 906 LA -906.947
		OM 906 LA -906.948
		OM 906 LA -906.949
		OM 906 LA -906.950



Package Weight : **10,750 kg**  
Package Dimensions : **24x40x16 cm**



**03.1303.00**



**09.2315.00**  
Ref : 4149810205



**03.2302.00**



**09.9002.00**  
Ref : 9062030615



**01.2303.00**  
Ref : 9062010107

REPAIR KIT

**15.3011.00**

Replaced Old Famco No : FM151711010

Oem Ref	Vehicle/Model	Engine
9062000304		OM 904 LA OM 906 LA / HLA OM 924 LA OM 926 LA M 906 LAG

Remarks

to fit water pumps:

906 200 6101	906 200 3801	906 200 1401	906 200 3701
906 200 6501	906 200 2901	906 200 1301	906 200 2601
906 200 5701	906 200 2801	906 200 0901	906 200 6201
906 200 5401	906 200 2201	906 200 5501	



WATER PUMP

**12.3021.00**

Replaced Old Famco No : FM151721000

Oem Ref	Vehicle/Model	Engine
9062006001		OM 904 LA
9062005201		OM 906 LA / HLA
9062002701		OM 924 LA
9062002601		OM 926 LA
		M 906 LAG



Package Weight : **10,550 kg**  
 Package Dimensions : **24x40x16 cm**

**03.1401.00****09.2314.00**  
Ref : 1689810727**03.2301.00****09.9002.00**  
Ref : 9062030615**01.2303.00**  
Ref : 9062010107

REPAIR KIT

**15.3021.00**

Replaced Old Famco No : FM151721010

Oem Ref	Vehicle/Model	Engine
		OM 904 LA
		OM 906 LA / HLA
		OM 924 LA
		OM 926 LA
		M 906 LAG





WATER PUMP

**12.3050.00**

Replaced Old Famco No : FM151751000

Oem Ref	Vehicle/Model	Engine
9062006301		OM 904 LA
9062005101		OM 924 LA
9062004301		OM 926 LA
9062004001		



Package Weight : **11,300 kg**  
Package Dimensions : **24x40x16 cm**



**03.1303.00**



**09.2315.00**  
Ref : 4149810205



**09.1537.00**  
Ref : 0149972845



**16.3050.00**



**01.2301.00**

REPAIR KIT

**15.3050.00**

Replaced Old Famco No : FM151751010

Oem Ref	Vehicle/Model	Engine
		OM 904 LA
		OM 924 LA
		OM 926 LA



WATER PUMP

**12.3200.00**

Replaced Old Famco No : FM184871000

Oem Ref	Vehicle/Model	Engine
5422002501		OM 501 LA OM 502 LA

\*impeller:  $\varnothing$  125 mm width: 12 mm

\*with metal gasket



Package Weight : **15,200 kg**  
 Package Dimensions : **24x40x21 cm**

**02.2302.00****09.2329.00**

**09.4004.00**  
 Ref : 0012012619



**01.2305.00**  
 Ref : 5422010007  
 $\varnothing$  125x15 12mm

REPAIR KIT

**15.3200.00**

Replaced Old Famco No : FM184871010

Oem Ref	Vehicle/Model	Engine
	ACTROS	OM 501 LA
	420kW 542.924	OM 502 LA
	448kW 542.956	

\* impeller:  $\varnothing$  125 mm width: 12 mm  
 \* with metal gasket



WATER PUMP

# 12.3210.00

Replaced Old Famco No : FM184881000

Oem Ref	Vehicle/Model	Engine
5422002601		OM 502 LA

\*impeller:  $\phi$  125 mm width: 12 mm

\*with metal gasket



Package Weight : **15,900 kg**  
Package Dimensions : **24x40x21 cm**



**02.2302.00**



**09.2329.00**



**09.4004.00**  
Ref : 0012012619



**01.2305.00**  
Ref : 5422010007  
 $\phi$  125x15 12mm

REPAIR KIT

# 15.3210.00

Replaced Old Famco No : FM184881010

Oem Ref	Vehicle/Model	Engine
	ACTROS 420kW 542.924 448kW 542.956	OM 502 LA

\* impeller:  $\phi$  125 mm width: 12 mm  
\* with metal gasket

Remarks  
to fit water pumps:  
5422002601  
5422002201  
5422001801



WATER PUMP

**12.3330.00**

Replaced Old Famco No : FM184891000

Oem Ref	Vehicle/Model	Engine
5412002301	541.970 - 978 - 980 -	OM 501 LA
5412002001	981 - 999	

\*impeller:  $\phi$  125 mm width: 8 mm

\*with metal gasket



Package Weight : **11,450 kg**  
 Package Dimensions : **24x40x16 cm**



**03.1403.00**  
 Ref : 4032020414



**09.2328.00**  
 Ref : 4032001802



**09.4004.00**  
 Ref : 0012012619



**01.2304.00**  
 Ref : 4412010207  
 $\phi$  125x15 8 mm

REPAIR KIT

**15.3180.00**

Replaced Old Famco No : FM180031010

Oem Ref	Vehicle/Model	Engine
	ACTROS	OM 501 LA
	315kW 521.940	
	230kW 541.920	
	315kW 541.921	
	260kW 541.922	
	290kW 541.923	
	315kW 541.925	

\*impeller:  $\phi$  125 mm width: 8 mm

\*with metal gasket

Remarks

to fit water pumps:

5412001201 5412001401  
 5412001101  
 5412000101



WATER PUMP

**12.3350.00**

Replaced Old Famco No :

Oem Ref	Vehicle/Model	Engine
4722001001		OM 470 LA -470.903
4722000401		OM 470 LA -470.904
4722000101		OM 470 LA -470.906
4722000001		OM 470 LA -470.907
		OM 470 LA -470.908
		OM 470 LA -470.917
		OM 471 LA -471.900
		OM 471 LA -471.901
		OM 471 LA -471.902
		OM 471 LA -471.903
		OM 471 LA -471.905
		OM 471 LA -471.906
		OM 471 LA -471.909
		OM 471 LA -471.910
		OM 471 LA -471.911
		OM 471 LA -471.913
		OM 471 LA -471.914
		OM 471 LA -471.915
		OM 473 LA -473.908
		OM 473 LA -473.909



Package Weight : **2,400 kg**  
Package Dimensions : **22,5x24,5x16 cm**



**03.1304.00**



**09.2352.00**



**09.4002.00**  
Ref: 21014261



**08.2301.00**  
Ø 103 mm



**08.3301.00**  
Ref: 4722020210



**09.1538.00**  
Ref: 4722010080

WATER PUMP

**13.3350.00**

Replaced Old Famco No :

Oem Ref	Vehicle/Model	Engine
		OM 470 LA
		OM 471 LA
		OM 473 LA



Package Weight : **3,400 kg**  
Package Dimensions : **22,5x24,5x16 cm**



WATER PUMP

**12.3360.00**

Replaced Old Famco No :

Oem Ref	Vehicle/Model	Engine
9362001501		OM 934 - 933.911
9362000801		OM 934 - 933.912
9362001101		OM 934 - 933.913
		OM 934 - 933.915
		OM 934 - 933.916
		OM 934 - 933.951
		OM 934 - 933.952
		OM 934 - 934.911
		OM 934 - 934.913
		OM 936 - 935.951
		OM 936 - 935.952
		OM 936 - 935.953
		OM 936 - 936.910
		OM 936 - 936.912

*\*impeller: ø 87,5 mm*

Package Weight : **3,000 kg**  
 Package Dimensions : **27x28x16 cm**

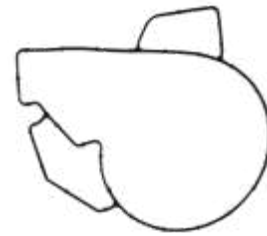

WATER PUMP

**12.3361.00**

Replaced Old Famco No :

Oem Ref	Vehicle/Model	Engine
9362001601		OM 934 - 933.951
9362001201		OM 934 - 933.952
9362000701		OM 936 - 935.951
		OM 936 - 935.952
		OM 936 - 935.953
		OM 936 - 935.954
		OM 936 - 936.910
		OM 936 - 936.912
		OM 936 - 936.916

*\*impeller: ø 99 mm*

Package Weight : **3,000 kg**  
 Package Dimensions : **27x28x16 cm**

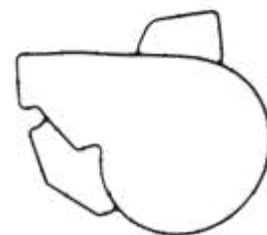

WATER PUMP

**12.3362.00**

Replaced Old Famco No :

Oem Ref	Vehicle/Model	Engine
9362001701		M 936 G - 936.991
9362001301		M 936 G - 936.993
9362000601		OM 934 - 933.951
		OM 934 - 933.952
		OM 936 - 935.911
		OM 936 - 935.912
		OM 936 - 935.913
		OM 936 - 935.914
		OM 936 - 935.951
		OM 936 - 935.952
		OM 936 - 935.953
		OM 936 - 935.954
		OM 936 - 936.910
		OM 936 - 936.912
		OM 936 - 936.916
		OM 936 - 936.919
		OM 936 - 936.923
		OM 936 - 936.972
		OM 936 - 936.973
		OM 936 H - 936.980

\*impeller: ø 101 mm



Package Weight : **3,000 kg**  
Package Dimensions : **27x28x16 cm**



**02.1301.00**



**09.2364.00**



**09.4002.00**  
Ref : 21014261

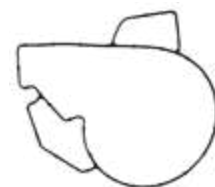

**09.1575.00**  
Ref : 9362010280



**08.2302.00**  
Ø 87,5mm



**08.2303.00**  
Ø 99mm



**08.2304.00**  
Ø 101mm

WATER PUMP

**12.3370.00**

Replaced Old Famco No :

Oem Ref	Vehicle/Model	Engine
4032007501		ADE 423 T1 - 493.900-501
4032006401		501

\*impeller:  $\varnothing$  125 mm (closed)

Package Weight : **12,450 kg**  
 Package Dimensions : **24x40x16 cm**



**03.1403.00**  
 Ref : 4032020414



**09.2328.00**  
 Ref : 4032001802



**09.4004.00**  
 Ref : 0012012619



**01.2305.00**  
 Ref : 4032011307  
 $\varnothing$  125x15 12mm



**09.5168.00**  
 Ref : 4422010280

WATER PUMP

**12.3371.00**

Replaced Old Famco No :

Oem Ref	Vehicle/Model	Engine
4222001201		
4222000701		

\*impeller:  $\varnothing$  135 mm

Package Weight : **12,450 kg**  
 Package Dimensions : **24x40x16 cm**





WATER PUMP

# 12.3310.00

Replaced Old Famco No : FM184901000

Oem Ref	Vehicle/Model	Engine
5412002701		OM 501 LA
5412001801		

\*with metal gasket



Package Weight : **14,150 kg**  
Package Dimensions : **24x40x16 cm**



WATER PUMP

# 12.3320.00

Replaced Old Famco No : FM184911000

Oem Ref	Vehicle/Model	Engine
5412001901		OM 501 LA
5412002601		
5412002801		

\*with metal gasket



Package Weight : **14,500 kg**  
Package Dimensions : **24x40x16 cm**



VOLVO

SCANIA

MERCEDES-BENZ

MAN

DAF

RENAULT

IVECO

OTHERS

FOR MAN



[www.famco.com.tr](http://www.famco.com.tr)

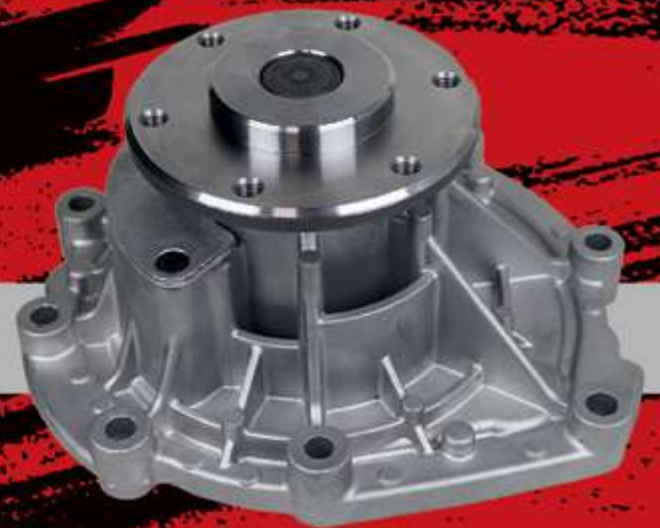

WATER PUMP

**12.4080.00**

Replaced Old Famco No : FM262810100

Oem Ref	Vehicle/Model	Engine
51065006282	V 28 00	E 2866 DOH 01/DF 01
51065006387	Z 37 00	D 2566 M/MF/MR/MFR
	Z 55 00	D 2566 UH/200
51065009282	Z 49 00	D 2565 MUL
51065009387	Z 65 00	D 2866 UH/UM/UM 01
	Z 65 01...	D 2866 UM01 IKARUS V/S...

\*impeller: ø 125 mm



Package Weight : **11,750 kg**  
Package Dimensions : **24x40x16 cm**



**03.1403.00**  
Ref : 51065040035



**09.2330.00**  
Ref : 51934100116



**09.4003.00**  
Ref : 51065200082



**01.2408.00**  
Ref : 51065060100  
Ø 125x16



**16.3230.00**

REPAIR KIT

**15.4080.00**

Replaced Old Famco No : FM262810110

Oem Ref	Vehicle/Model	Engine
	V 28 00	E 2866 DOH 01/DF 01
	Z 37 00	D 2566 M/MF/MR/MFR
	Z 55 00	D 2566 UH/200
	Z 49 00	D 2565 MUL
	Z 65 00	D 2866 UH/UM/UM 01
	Z 65 01	D 2866 UM01 IKARUS
	Z 65 02	V/S
	Z 88 00	D 2866 UH
	Z 92 00	D 2866 FG
		D 2866 F/FR
		D 2866 OH
		D 2530 MTXF
		D 2566 MUH

\*impeller: ø 125 mm (closed)

Remarks

to fit water pumps:  
51065006282  
51065006387



WATER PUMP

**12.4081.00**

Replaced Old Famco No : FM262811100

Oem Ref	Vehicle/Model	Engine
51065006408	V01 00	D2866 TUH/TUH01/TUM
	V01 01	D2866 TUH01 IKARUS
	V04 00	G2866 UH/UM/DUH01-05/
	V05 00	DUM01
	V06 00	D2865 LU01-06
	V07 00	D2840 LF01/04/06
	V10 00	D2865 LF/LFR/LXF/
	V13 00	LXFR/LF01.../LFR01...
	V15 00...	D2866 LH01/02...

\*impeller: ø 135 mm



Package Weight : **11,700 kg**  
Package Dimensions : **24x40x16 cm**



**03.1403.00**  
Ref : 51065040035



**09.2330.00**  
Ref : 51934100116



**09.5137.00**  
Ref : 51069010183



**01.2403.00**  
Ref : 51065065001  
Ø 135x16



**01.2406.00**  
Ref : 51065060090  
Ø 135x16

REPAIR KIT

**15.4048.00**

Replaced Old Famco No : FM194000110

Oem Ref	Vehicle/Model	Engine
	V 07 00	D 2865 LF/LFR/LXF/
	V 25 00	LXFR/
	Z 76 01	LF01.../LFR01
	Z 76 03	D 2865 LF 21-24
	Z 76 04	D 2866 LF02-10/14-17
	V 26 00	D 2866 LF05
	V 26 02	D 2866 LF05
	V 26 05	D 2866 LF 20-25/29-
	V 26 01	31/34/
	V 26 04	35/39/40
		D 2866 LF 20/21
		D 2866 LF 21
		D 2866 LF 21
		D 2866 LF 22

\*impeller: ø 135 mm (closed)

Remarks

to fit water pumps:  
51065006545 51065006408  
51065006547  
51065006492



WATER PUMP

**12.4040.00**

Replaced Old Famco No : FM194220100

Oem Ref	Vehicle/Model Engine	
51065006545	V 07 00	D 2865 LF/LFR/LXF/LXFR/
51065009545	V 25 00	LF01../LFR01
	Z 76 01	D 2865 LF 21-24
	Z 76 03	D 2866 LF02-10/14-17
	Z 76 04	D 2866 LF05
	V 26 00	D 2866 LF05
	V 26 02	D 2866 LF 20-25/29-31/34/
	V 26 05	35/39/40
	V 26 01	D 2866 LF 20/21
	V 26 04	D 2866 LF 21
		D 2866 LF 21
		D 2866 LF 22

\*impeller: ø 135 mm



Package Weight : **13,000 kg**  
Package Dimensions : **24x40x16 cm**



**01.3401.00**  
Ref : 51065030325



**09.2330.00**  
Ref : 51934100116



**09.4003.00**  
Ref : 51065200082



**01.2403.00**  
Ref : 51065065001  
Ø 135x16



**09.5134.00**  
Ref : 51069010156

REPAIR KIT

**15.4040.00**

Replaced Old Famco No : FM194001110

Oem Ref	Vehicle/Model	Engine
	V 01 00	D 28 66 TUH/TUH 01/TUM
	V 01 01	D 28 66 TUH01/IKARUS
	V 05 00	D 28 65 LU 01/02/03
	V 06 00	D 28 40 LF 01/04/06
	V 10 00	D 28 66 LH 01/02
	V 13 00	D 28 66 LUH/LXUH/LUH 05
	V 14 00	D 28 65 LUH 02/03/05-09
	V 15 00	D 28 66 LOH 20-26/30/31
	V 16 00	E 28 66 DUH 01
	Z 20 00	D 25 66 MKUL
		D 25 66 M/MF/MFR
		D 28 66 KUH
		D 28 66 FZR

\*impeller: ø 135 mm

Remarks

to fit water pumps:

- 51065006546 51065006526
- 51065006426 51065009526
- 51065006490 51065006492
- 51065006616 51065009492



WATER PUMP

**12.4050.00**

Replaced Old Famco No : FM194630100

Oem Ref	Vehicle/Model	Engine
51065006547	V 07 00	D 2865 LF/LFR/LXF/
51065009547	V 24 00	LXFR/LF01../LFR01
	V 24 01	D 2876 LF 01-
	V 25 00	03/06/08-10/14/17
	V 26 00	D 2876 LF 06
	V 26 02	D 2865 LF 21-24
	Z 76 01	D 2866 LF 20-25/29-31/34/35/39/40
		D 2866 LF 20/21
		D 2866 LF02-10/14-17

\*impeller: ø 135 mm



Package Weight : **12,800 kg**  
Package Dimensions : **24x40x16 cm**



**01.3401.00**  
Ref: 51065030325



**09.2330.00**  
Ref: 51934100116



**09.4003.00**  
Ref: 51065200082



**01.2403.00**  
Ref: 51065065001  
Ø 135x16



**09.5136.00**

GASKET KIT

**16.4040.00**

Replaced Old Famco No : FM194000108

Oem Ref	Vehicle/Model	Engine
51065996051	M 212 00	BAUREIHE D28.. (R+V ALT)
	M 244 00	D2865
	M 246 00	LOH01/02/05/07-10
	M 248 00	D2865 LUH02/03/05-09
	M 249 00	D2865 LF/LFR/LXF/
	M 256 00	LXFR/LF01../LFR01...
	M 259 00	D2565 MUL
	M 268 00	D2865 LF21-24
	M 272 00	D2865 LU01-06
	M 274 00	D2866 F/FR
	M 293 00	D2866 FG
	M 294 00	D2866 OH
	M 294 01	G2866 UH/UM/
	M 303 00	DUH01-05/DUM01
	M 309 00	E2866 DUH01
	M 309 01	
	M 309 02	



WATER PUMP

**12.4020.00**

Replaced Old Famco No : FM121530100

Oem Ref	Vehicle/Model	Engine
51065006515	V 19 00	D 0824
51065006532	V 23 00	LOH01/02/03/04/05
51065009515	V 18 00	D 0826 LFL03/06-10
51065009532	V 47 00	D 0824 LFO1
	V 17 00	D 0824 LFG01/02/04-10/
	V 17 01	LFO-01
	V 23 01	D 0824 LFL09/10
		D 0826 LFL03/06-10
		D 0826 LFL10-PAKISTAN

\*impeller: ø 110 mm



Package Weight : **9,500 kg**  
Package Dimensions : **24x40x16 cm**



**03.1403.00**

Ref : 51065040035



**09.2330.00**

Ref : 51934100116



**09.4003.00**

Ref : 51065200082



**01.2402.00**

Ref : 51065060066  
Ø 110x16



**09.5138.00**

Ref : 51069010107

REPAIR KIT

**15.4020.00**

Replaced Old Famco No : FM121530110

Oem Ref	Vehicle/Model	Engine
51065996068	V 19 00	D 0824 LOH01/02/03/04/05
51065996060	V 23 00	D 0826 LFL03/06-10
	V 18 00	D 0824 LFO1
	V 47 00	D 0824 LFG01/02/04-10/
	V 17 00	LFO-01
	V 17 01	D 0824 LFL09/10
	V 23 01	D 0826 LFL03/06-10
		D 0826 LFL10-PAKISTAN

\*impeller: ø 110 mm



WATER PUMP

**12.4060.00**

Replaced Old Famco No : FM262300100

Oem Ref	Vehicle/Model	Engine
51065006476	V 38 00	D 0824 LE301
51065006462	V 27 00	D 0824 LF01/02
	V 19 00	D 0824
51065009476	V 02 00	LOH01/02/03/04/05
51065009462	V 21 00	D 0826 F/FR/F01/02/FR01-02
	Z 95 00	
	Z 95 01	D 0826 FO/FO-01/02
	V 30 00	D 0826 LF/LF217/LF01/02/04
	V 11 00	D 0826 LF01
	V 23 00	D 0826 LF15/17/18
	V 09 00	D 0826 LFG01/02/06
	V 09 01	D 0826 LFL03/06-10
	V 29 00	D 0826 LOH/LOH01-13
	V 93 00	D 0826 LOH 07
	V 94 00	D 0826 LOH 15/17/18/19
		D 0826 OH/OH01-13
		D 0826 TF

\*impeller: ø 125 mm (closed)



Package Weight : **8,000 kg**  
Package Dimensions : **24x40x16 cm**



**03.1403.00**  
Ref : 51065040035



**09.5140.00**  
Ref : 51069010119



**09.5139.00**  
Ref : 51069010118



**01.2408.00**  
Ref : 51065060100  
Ø 125x16



**16.4060.00**

REPAIR KIT

**15.4060.00**

Replaced Old Famco No : FM262300110

Oem Ref	Vehicle/Model	Engine
51065996052	V 38 00	D 0824 LE301
	V 27 00	D 0824 LF01/02
	V 19 00	D 0824 LOH01/02/03/04/05
	V 02 00	D 0826 F/FR/F01/02/FR01-02
	V 21 00	D 0826 FO/FO-01/02
	Z 95 00	D 0826 LF/LF217/LF01/02/04
	Z 95 01	D 0826 LF01
	V 30 00	D 0826 LF15/17/18
	V 11 00	D 0826 LFG01/02/06
	V 23 00	D 0826 LFL03/06-10
	V 09 00	D 0826 LOH/LOH01-13
	V 09 01	D 0826 LOH 07
	V 29 00	D 0826 LOH 15/17/18/19
	V 93 00	D 0826 OH/OH01-13
	V 94 00	D 0826 TF

\*impeller: ø 125 mm (closed)





WATER PUMP

**12.4010.00**

Replaced Old Famco No : FM002320100

Oem Ref	Vehicle/Model	Engine
51065006537	V 27 00	D 0824 LF01/02
51065009537	V 17 00	D0824LF01/02/04-10/ LFO-01
	V 19 00	D 0824
	V 19 01	LOH01/02/03/04/05
	Z 95 00	D 0824 LOH05
	V 30 00	D0826LF/LF217/ LF01/02/04
	V 41 00	D 0826 LF15/17/18
	V 23 00	D 0826 LFG15/16
	V 29 00	D 0826 LFL03/06-10
		D 0826 LOH15/17/18/19

\*impeller: ø 125 mm



Package Weight : **8,300 kg**  
Package Dimensions : **24x40x16 cm**



**03.1403.00**

Ref : 51065040035



**09.2330.00**

Ref : 51934100116



**09.4003.00**

Ref : 51065200082



**01.2401.00**

Ref : 51085063060  
Ø 125x16



**09.5140.00**

Ref : 51069010119

REPAIR KIT

**15.4010.00**

Replaced Old Famco No : FM002320110

Oem Ref	Vehicle/Model	Engine
51065996067	V 27 00	D 0824 LF01/02
	V 17 00	D 0824 LF01/02/04-10/ LFO-01
	V 19 00	D 0824 LOH01/02/03/04/05
	V 19 01	D 0824 LOH05
	Z 95 00	D 0826 LF/LF217/ LF01/02/04
	V 30 00	D 0826 LF15/17/18
	V 41 00	D 0826 LFG15/16
	V 23 00	D 0826 LFL03/06-10
	V 29 00	D 0826 LOH15/17/18/19

\*impeller: ø 125 mm



WATER PUMP

**12.4011.00**

Replaced Old Famco No : FM002321100

Oem Ref	Vehicle/Model	Engine
51065006554	M 012 00	BAUREIHE D/ E08..
51065009554	M 158 00	D0826 LFL03/ 06-10
	M 178 00	D0826 LF/ LF217/ LF01/ 02/
	M 184 00	D0826 LOH15/ 17/ 18/ 19
	M 186 00	D0826 LFG15/ 16
	M 188 00	D0826 LF15/ 17/18

\*impeller: ø 135 mm



Package Weight : **8,300 kg**  
 Package Dimensions : **24x40x16 cm**



**03.1403.00**  
 Ref : 51065040035



**09.2330.00**  
 Ref : 51934100116



**09.4003.00**  
 Ref : 51065200082



**01.2403.00**  
 Ref : 51065065001  
 Ø 135x16

REPAIR KIT

**15.4011.00**

Replaced Old Famco No : FM002321110

Oem Ref	Vehicle/Model	Engine
	V 27 00	D 0824 LF01/02
	V 17 00	D 0824 LF01/02/04-10/
	V 19 00	LFO-01
	V 19 01	D 0824 LOH01/02/03/04/05
	Z 95 00	D 0824 LOH05
	V 30 00	D 0826 LF/LF217/
	V 41 00	LF01/02/04
	V 23 00	D 0826 LF15/17/18
	V 29 00	D 0826 LFG15/16
		D 0826 LFL03/06-10
		D 0826 LOH15/17/18/19

\*impeller: ø 135 mm



WATER PUMP

**12.4090.00**

Replaced Old Famco No : FM322700100

Oem Ref	Vehicle/Model	Engine
51065006669	V 39 00	D 0836 LFL01-06
51065006612	V 40 00	D 0836 LF01/03-05
51065006606	V 44 00	D 0834 LFL01
51065006575	V 49 00	D 0836
51065009669	V 51 00	L0H01/02/03/04
51065009612	V 61 00	D 0834
51065009606		L0H01/02/03
51065009575		D 0836 LFG01

\*impeller: ø 125 mm



Package Weight : **8,500 kg**  
Package Dimensions : **24x40x16 cm**



**03.1403.00**  
Ref : 51065040035



**09.2330.00**  
Ref : 51934100116



**09.4003.00**  
Ref : 51065200082



**01.2401.00**  
Ref : 51085063060  
Ø 125x16



**09.5141.00**  
Ref : 51069010184

REPAIR KIT

**15.4090.00**

Replaced Old Famco No : FM322700110

Oem Ref	Vehicle/Model	Engine
51065996081	V 39 00	D 0836 LFL01-06
	V 40 00	D 0836 LF01/03-05
	V 44 00	D 0834 LFL01
	V 49 00	D 0836
	V 51 00	L0H01/02/03/04
	V 61 00	D 0834 L0H01/02/03
		D 0836 LFG01

\*impeller: ø 125 mm



WATER PUMP

**12.4070.00**

Replaced Old Famco No : FM262700100

Oem Ref	Vehicle/Model	Engine
51065006495	V 09 00	D 0826 LOH/LOH01-13
51065006463	Z 95 00	D 0826 LF/LF217/ LF01/02/04
51065009495	Z 86 00	D 0826 TOH
51065009463	Z 86 01	G 0826 DOH D 2865 LF21/22/23

\*impeller: ø 135 mm



Package Weight : **8,000 kg**  
Package Dimensions : **24x40x16 cm**



**03.1403.00**  
Ref : 51065040035



**09.2330.00**  
Ref : 51934100116



**09.4003.00**  
Ref : 51065200082



**01.2403.00**  
Ref : 51065065001  
Ø 135x16

REPAIR KIT

**15.4070.00**

Replaced Old Famco No : FM262700110

Oem Ref	Vehicle/Model	Engine
	V 09 00	D 0826 LOH/LOH01-13
	Z 95 00	D 0826 LF/LF217/LF01/02/04
	Z 86 00	D 0826 TOH
	Z 86 01	G 0826 DOH D 2865 LF21/22/23

\*impeller: ø 135 mm



WATER PUMP

**12.4042.00**

Replaced Old Famco No : FM194231100

Oem Ref	Vehicle/Model	Engine
51065006426	V 01 00	D 28 66 TUH/TUH 01/TUM
51065006490	V 01 01	D 28 66 TUH01/IKARUS
51065009426	V 05 00	D 28 65 LU 01/02/03
51065009426	V 06 00	D 28 40 LF 01/04/06
51065009490	V 10 00	D 28 66 LH 01/02
	V 13 00	D 28 66 LUH/LXUH/LUH 05
	V 14 00	D 28 65 LUH 02/03/05-09
	V 15 00	D 28 66 LOH 20-26/30/31
	V 16 00	E 28 66 DUH 01
	Z 20 00	D 25 66 MKUL
	Z 36 00	D 25 66 M/MF/MFR
	Z 64 00	D 28 66 KUH
	Z 78 00	D 28 66 FZR
	Z 79 00	D 28 66 TOH
	Z 92 00	D 28 66 F/FR
	Z 96 00	D 28 66 OH

\*impeller: ø 135 mm



Package Weight : **12,400 kg**  
Package Dimensions : **24x40x16 cm**



**03.1403.00**  
Ref : 51065040035



**09.2330.00**  
Ref : 51934100116



**09.4003.00**  
Ref : 51065200082



**01.2403.00**  
Ref : 51065065001  
Ø 135x16



**16.4042.00**

REPAIR KIT

**15.4040.00**

Replaced Old Famco No : FM194001110

Oem Ref	Vehicle/Model	Engine
	V 01 00	D 28 66 TUH/TUH 01/TUM
	V 01 01	D 28 66 TUH01/IKARUS
	V 05 00	D 28 65 LU 01/02/03
	V 06 00	D 28 40 LF 01/04/06
	V 10 00	D 28 66 LH 01/02
	V 13 00	D 28 66 LUH/LXUH/LUH 05
	V 14 00	D 28 65 LUH 02/03/05-09
	V 15 00	D 28 66 LOH 20-26/30/31
	V 16 00	E 28 66 DUH 01
	Z 20 00	D 25 66 MKUL
		D 25 66 M/MF/MFR
		D 28 66 KUH
		D 28 66 FZR

\*impeller: ø 135 mm

Remarks

to fit water pumps:

- 51065006546 51065006526
- 51065006426 51065009526
- 51065006490 51065006492
- 51065006616 51065009492



WATER PUMP

**12.4180.00**

Replaced Old Famco No : FM194233100

Oem Ref	Vehicle/Model	Engine
51065006526	LE 401	D 2866
51065009526	LE 402 LE 403 LE 405	

\*Hole : 35 mm



Package Weight : **12,300 kg**  
Package Dimensions : **24x40x16 cm**



**03.1403.00**  
Ref : 51065040035



**09.2330.00**  
Ref : 51934100116



**09.4003.00**  
Ref : 51065200082



**01.2403.00**  
Ref : 51065065001  
Ø 135x16



**16.4180.00**

REPAIR KIT

**15.4042.00**

Replaced Old Famco No :

Oem Ref	Vehicle/Model	Engine
V 01 00		D 28 66 TUH/TUH 01/TUM
V 01 01		D 28 66 TUH01/IKARUS
V 05 00		D 28 65 LU 01/02/03
V 06 00		D 28 40 LF 01/04/06
V 10 00		D 28 66 LH 01/02
V 13 00		D 28 66 LUH/LXUH/LUH 05
V 14 00		D 28 65 LUH 02/03/05-09
V 15 00		D 28 66 LOH 20-26/30/31
V 16 00		E 28 66 DUH 01
Z 20 00		D 25 66 MKUL D 25 66 M/MF/MFR D 28 66 KUH D 28 66 FZR

\*impeller: ø 135 mm

Remarks

to fit water pumps:

51065006546 51065006526  
51065006426 51065009526  
51065006490 51065006492  
51065006616 51065009492



WATER PUMP

**12.4041.00**

Replaced Old Famco No : FM194230100

Oem Ref	Vehicle/Model	Engine
51065006546	V 24 00	D 28 76 LF 01-
51065009546	V 25 00	03/06/08/09/10
	V 26 00	D 28 65 LF 21-24
	V 28 00	D 28 66 LF 20-
	Z 76 01	25/29/31/34/35/39/40
		E 28 66 DOH 01/DF 01
		D 28 66 LF 02-10/14-17

\*impeller: ø 135 mm



Package Weight : **13,700 kg**  
Package Dimensions : **24x40x16 cm**



**01.3401.00**



**09.2330.00**  
Ref : 51934100116



**09.4003.00**  
Ref : 51065200082



**01.2403.00**  
Ref : 51065065001  
Ø 135x16



**09.5159.00**  
Ref : 51069010160

REPAIR KIT

**15.4041.00**

Replaced Old Famco No : FM194000109

Oem Ref	Vehicle/Model	Engine
51065996033	M 012 00	BAUREIHE D/E08..
51065996035	M 212 00	BAUREIHE D28.. (R+V ALT)
51065996010	M 241 00	D2565 M/MF/MFR
51065996011	M 244 00	D2865 LOH01/02/05
51065996012	M 246 00	D2865 LUH02/03/05-09
	M 248 00	D2865 LF/LFR/LXF/LXFR/
	M 249 00	LF01.../LFR01...
	M 256 00	D2565 MUL
	M 259 00	D2865 LF21-24
	M 268 00	D2865 LU01-06
	M 272 00	D2866 F/FR
	M 274 00	D2866 FG
	M 276 00	D2866 OH
	M 278 00	E2866 DOH01/DF01
	M 286 00	E2866 DUH01
	M 293 00	E2866 DUH01/02/03/04



WATER PUMP

**12.4110.00**

Replaced Old Famco No : FM416800100

Oem Ref	Vehicle/Model	Engine
51065007049	V 55 00	D 2066 LF 01
51065006637	V 55 02	04/06/07/11
51065009049	V 73 00	D 2066 LF 01 (USA) D 2066 LF 01/11/12

\*with metal gasket



Package Weight : **4,100 kg**  
Package Dimensions : **22,5x24,5x16 cm**



**03.1403.00**  
Ref : 51065040050  
51065040049



**09.2330.00**  
Ref : 51934100116



**09.4003.00**  
Ref : 51065200085



**01.2405.00**  
Ref : 51065060123  
51065063069

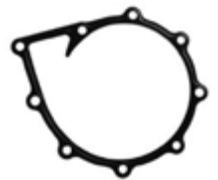

**09.5143.00**  
Ref : 51069010192  
(Metal Gasket)

REPAIR KIT

**15.4110.00**

Replaced Old Famco No : FM416800110

Oem Ref	Vehicle/Model	Engine
51065996086	V 55 00 V 55 02 V 73 00	D 2066 LF 01 04/06/07/11 D 2066 LF 01 (USA) D 2066 LF 01/11/12

\*with metal gasket





WATER PUMP

**12.4120.00**

Replaced Old Famco No : FM416801100

Oem Ref	Vehicle/Model	Engine
51065006694	V 55 00	D 2066 LF01 04/06/07/
51065006642	V 55 01	11-14/21/22 31-35
51065006675	V 55 03	D 2066 LF 34 (MOD UK)
51065009694	V 65 00	D 2066 LF 34 (DAENISCHE
51065009694	V 67 00	ARMEE)
51065009642	V 70 00	D 2066 LOH
51065009642	V 70 01	01/02/03/04/10
51065009675	V 73 00	D 2676 LOH 01/02
		D 2066 LFG 01
		D 2066 LFG 01 (MOD UK)
		D 2676 LF 01/11/12

\*with metal gasket



Package Weight : **3,500 kg**  
Package Dimensions : **22,5x24,5x16 cm**



**03.1403.00**  
Ref : 51065040035



**09.2330.00**  
Ref : 51934100116



**09.4003.00**  
Ref : 51065200082



**06.1401.00**  
Ref : 51065060129

REPAIR KIT

**15.4120.00**

Replaced Old Famco No : FM416801110

Oem Ref	Vehicle/Model	Engine
51065996091	V 55 00	D 2066 LF01 04/06/07/11-14
51065996094	V 55 01	/21/22 31-35
	V 55 03	D 2066 LF 34 (MOD UK)
	V 65 00	D 2066 LF 34 (DAENISCHE
	V 67 00	ARMEE)
	V 70 00	D 2066 LOH 01/02/03/04/10
	V 70 01	D 2676 LOH 01/02
	V 73 00	D 2066 LFG 01
		D 2066 LFG 01 (MOD UK)
		D 2676 LF 01/11/12

\*with metal gasket

Remarks

to fit water pumps:  
51065006642  
51065006646  
51065007078



WATER PUMP

**12.4140.00**

Replaced Old Famco No : FM416802100

Oem Ref	Vehicle/Model	Engine
51065006676	V 64 00	D 2066 LUH 01/11 - 18/21..
51065006646		
51065006695		
51065007050		
51065009676		
51065009646		
51065009695		
51065009050		

\*with metal gasket



Package Weight : **3,300 kg**  
 Package Dimensions : **22,5x24,5x16 cm**



**03.1403.00**  
 Ref: 51065040035



**09.2330.00**  
 Ref: 51934100116



**09.4003.00**  
 Ref: 51065200082



**06.1401.00**  
 Ref: 51065060129

REPAIR KIT

**15.4120.00**

Replaced Old Famco No : FM416801110

Oem Ref	Vehicle/Model	Engine
51065996091	V 55 00	D 2066 LF01 04/06/07/11-14
51065996094	V 55 01	/21/22 31-35
	V 55 03	D 2066 LF 34 (MOD UK)
	V 65 00	D 2066 LF 34 (DAENISCHE ARMEE)
	V 67 00	D 2066 LOH 01/02/03/04/10
	V 70 00	D 2676 LOH 01/02
	V 70 01	D 2066 LFG 01
	V 73 00	D 2066 LFG 01 (MOD UK)
		D 2676 LF 01/11/12

\*with metal gasket

Remarks

to fit water pumps:

- 51065006642
- 51065006646
- 51065007078



WATER PUMP

**12.4150.00**

Replaced Old Famco No : FM416803100

Oem Ref	Vehicle/Model	Engine
51065006680	TGL	BAUREIHE D/E08..
51065007079	TGM	D0836 LOH10/11
51065006651	V52 00	D0834 LFL50-55/57
51065007070	V56 00	D0834
51065007070	V60 00	LOH40/50/51/52/53/60/61
51065009070	V63 00	E0836 LOH
51065009680	V68 00	D0836 LOH51-58/60-68/70-73
51065009079	V71 00	
51065009079	V78 00	D0836 LFL50-56
51065009651	V79 00	D0836 LFG50
51065009700		D0836 LFG50 (MOD UK)
51065006700		

\*Thread : M16 x 1,5

\*with metal gasket



Package Weight : **3,450 kg**  
Package Dimensions : **22,5x24,5x16 cm**



**03.1403.00**  
Ref : 51065040035



**09.2330.00**  
Ref : 51934100116



**09.4003.00**  
Ref : 51065200082



**06.1401.00**  
Ref : 51065060129



**09.5142.00**  
Ref : 51069010187  
(Paper Gasket)

REPAIR KIT

**15.4150.00**

Replaced Old Famco No : FM416803110

Oem Ref	Vehicle/Model	Engine
V 55 00		D 2066 LF01 04/06/07/11-14
V 55 01		/21/22 31-35
V 55 03		D 2066 LF 34 (MOD UK)
V 65 00		D 2066 LF 34 (DAENISCHE
V 67 00		ARMEE)
V 70 00		D 2066 LOH 01/02/03/04/10
V 70 01		D 2676 LOH 01/02
V 73 00		D 2066 LFG 01
		D 2066 LFG 01 (MOD UK)
		D 2676 LF 01/11/12

\*with metal gasket

Remarks

to fit water pumps:

51065006680 51065007078  
51065007079 51065007064  
51065006651  
51065006679



WATER PUMP

**12.4160.00**

Replaced Old Famco No : FM416804100

Oem Ref	Vehicle/Model	Engine
51065006679	TGL	BAUREIHE D/E08..
51065007078	TGM	D0836 LOH10/11
51065007064	V52 00	D0834 LFL50-55/57
51065009679	V56 00	D0834
51065009679	V60 00	LOH40/50/51/52/53/60/61
51065009078	V63 00	E0836 LOH
51065009064	V68 00	D0836 LOH51-58/60-68/70-73
51065009699	V71 00	D0836 LFL50-56
51065009699	V78 00	D0836 LFG50
51065006699	V79 00	D0836 LFG50 (MOD UK)

\*Thread : M14 x 1,5

\*with metal gasket



Package Weight : **3,450 kg**  
 Package Dimensions : **22,5x24,5x16 cm**



**03.1403.00**  
 Ref : 51065040035



**09.2330.00**  
 Ref : 51934100116



**09.4003.00**  
 Ref : 51065200082



**06.1401.00**  
 Ref : 51065060129



**09.5164.00**  
 Ref : 51069010196  
 (Metal Gasket)

REPAIR KIT

**15.4150.00**

Replaced Old Famco No : FM416803110

Oem Ref	Vehicle/Model	Engine
	V 55 00	D 2066 LF01 04/06/07/11-14
	V 55 01	/21/22 31-35
	V 55 03	D 2066 LF 34 (MOD UK)
	V 65 00	D 2066 LF 34 (DAENISCHE
	V 67 00	ARMEE)
	V 70 00	D 2066 LOH 01/02/03/04/10
	V 70 01	D 2676 LOH 01/02
	V 73 00	D 2066 LFG 01
		D 2066 LFG 01 (MOD UK)
		D 2676 LF 01/11/12

\*with metal gasket

Remarks

to fit water pumps:

51065006680 51065007078  
 51065007079 51065007064  
 51065006651  
 51065006679



WATER PUMP

**12.4161.00**

Replaced Old Famco No :

Oem Ref	Vehicle/Model	Engine
51065006587		M 012 00 - BAUREIHE DE08.. M 183 00 - D0836 LUH01/02 M 193 00 - D0836 LUH40 / 41 / 50

\*Thread : M14 x 1,5

\*with metal gasket



Package Weight : **4,300 kg**  
Package Dimensions : **22,5x24,5x16 cm**



**03.1403.00**  
Ref : 51065040035



**09.2330.00**  
Ref : 51934100116



**09.4003.00**  
Ref : 51065200082



**01.2411.00**



**09.5164.00**  
Ref : 51069010196  
(Metal Gasket)

REPAIR KIT

**15.4161.00**

Replaced Old Famco No :

Oem Ref	Vehicle/Model	Engine
V 55 00		D 2066 LF 01
V 55 02		04/06/07/11
V 73 00		D 2066 LF 01 (USA) D 2066 LF 01/11/12



WATER PUMP

**12.4170.00**

Replaced Old Famco No : FM416805100

Oem Ref	Vehicle/Model	Engine
51065009106		BAUREIHE D28.. (R+V ALT)
51065007102		BAUREIHE D38.. PROTOTYP
51065009000		D2066 LOH01-08/10-12/ 26-28/32-40
51065007106		D2066 LF01-04/6/7/11-53/ 57-65/69-72/81-84
51065007130		D2676 LOH01-04/10/26-28/ 31-34
		D2676 LF01-8/10-22/25-28/ 31-33/37-50/54-55
		D3876 LF01/02

\*with metal gasket



Package Weight : **4,250 kg**  
Package Dimensions : **22,5x24,5x16 cm**



**03.1403.00**  
Ref : 51065040035



**09.2339.00**



**09.4003.00**  
Ref : 51065200082



**06.1402.00**  
Ref : 100015802



**09.5156.00**  
Ref : 51069010215  
(Metal Gasket)

REPAIR KIT

**15.4170.00**

Replaced Old Famco No : FM416805110

Oem Ref	Vehicle/Model	Engine
		BAUREIHE D28.. (R+V ALT)
		BAUREIHE D38.. PROTOTYP
		D2066 LOH01-08/10-12/ 26-28/32-40
		D2066 LF01-04/6/7/11-53/ 57-65/69-72/81-84
		D2676 LOH01-04/10/26-28/ 31-34
		D2676 LF01-8/10-22/25-28/ 31-33/37-50/54-55
		D3876 LF01/02

\*with metal gasket



WATER PUMP

**12.4100.00**

Replaced Old Famco No : FM415300100

Oem Ref	Vehicle/Model	Engine
51065007089	TGA	D 2866 LF 26-28/32/36/37
51065007066	V4200	D 2876 LF 04/07
51065007052	V4300	D2876 LF01-03/06/08-10/14/17
51065007051	V24 00	D2866 LF20-25/29-31/34/35/38/39/40/45
51065007048	V26 00	D2866 LF24-OEBH
51065007047	V26 06	D2866 LF26-28/32/36/37/41/43
51065007045	V42 00	D2876
51065007044	V43 00	LF04/05/07/11/20/21/22/24
51065007043	V53 00	D2876 LF12/13/25
51065007037		
51065007036		
51065007033		
51065009066		
51065009052		
51065009051		
51065009048		
51065009047		
51065009045		
51065009044		



Package Weight : **11,500 kg**  
Package Dimensions : **32x53x18 cm**



**01.2409.00**  
Ref : 51065066009



**09.1202.00**  
Ref : 51900200365



**09.1809.00**  
Ref : 06290290197



**09.4011.00**  
Ref : 51065200108  
51065200102



**04.5401.00**  
Ref : 51065126001

REPAIR KIT

**15.4100.00**

Replaced Old Famco No : FM415300110

Oem Ref	Vehicle/Model	Engine
	TGA	D 2866 LF 26-28/32/36/37
	V4200	D 2876 LF 04/07
	V4300	D2876 LF01-03/06/08-10/14/17
	V24 00	D2866 LF20-25/29-31/34/35/38/39/40/45
	V26 00	D2866 LF24-OEBH
	V26 06	D2866 LF26-28/32/36/37/41/43
	V42 00	D2876
	V43 00	
	V53 00	



WATER PUMP

**12.4051.00**

Replaced Old Famco No : FM194631100

Oem Ref	Vehicle/Model	Engine
51065006492	V 05 00	D 2865 LU 01/02/03
51065009492	V 07 00	D 2865 LF/LFR/LXF/IXFR/
	V 14 00	LF01..LFR01...
	V 15 00	D 2865 LUH 02/03/05-09
	V 22 00	D 2866 LOH 20-26/30/31
	V 24 00	D 2865 LOH 01/02/05/07-
	V 25 00	10
	V 26 00	D 2876 LF 01-03/06/08-
	V 32 00	10/14/17
	V 32 02	D 2865 LF 21-24
	V 33 00	D 2866 LF 20-25/29-
	V 45 00	31/34/35/38/39/40/45
	Z 68 00	D 2866 LUH 20/21/22/26
	Z 76 00	D 2866 LUH
	Z 76 01	21-ADTRANZ
	Z 89 00	D 2876 LOH 01
		D 2876 LOH 02/03/04/05
		D 2866 LU/LUL/LXU/
		LU01/03/04/07/08
		D 2866 LF/LXF
		D 2866 LF 02-10/14-17
		D 2866 LFG/LXFG

\*impeller: ø 135 mm

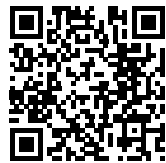

Package Weight : **11,650 kg**  
 Package Dimensions : **24x40x16 cm**



**03.1403.00**  
 Ref : 51065040035



**09.2330.00**  
 Ref : 51934100116



**09.4003.00**  
 Ref : 51065200082



**01.2403.00**  
 Ref : 51065065001  
 Ø 135x16

GASKET KIT

**16.4100.00**

Replaced Old Famco No : FM415300109

Oem Ref	Vehicle/Model	Engine
	TGA	D 2866 LF 26-28/32/36/37
	V4200	D 2876 LF 04/07
	V4300	D2876LF01-03/06/08-10/14/17
	V24 00	D2866 LF20-25/29-
	V26 00	31/34/35/38/39/40/45
	V26 06	D2866 LF24-OEBH
	V42 00	D2866LF26-28/32/36/37/41/43
	V43 00	D2876
	V53 00	





WATER PUMP

**12.4030.00**

Replaced Old Famco No : FM121540100

Oem Ref	Vehicle/Model	Engine
51065006432	V12 00	D0826 GFA02
51065006423	Z57 00	D0226 MKF/MKH/MKFA/ MKFO/MKF-CA/USA
51065006416	Z81 00	D0224 M
51065006394	Z82 00	D0824 GF/GF01/02/03
51065006374	Z83 00	KOOP-VW
51065009432		D0826 GF/GFA/ GF01/03/04/GFA01/03/04
51065009423		KOOP-VW

\*impeller: ø 110 mm

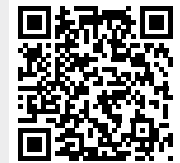

Package Weight : **7,250 kg**  
Package Dimensions : **21x31x18 cm**



**03.1402.00**  
Ref : 51065040031



**09.2331.00**



**09.4003.00**  
Ref : 51065200082



**01.2402.00**  
Ref : 51065060066  
Ø 110x16



**09.5138.00**  
Ref : 51069010107

REPAIR KIT

**15.4030.00**

Replaced Old Famco No : FM121540110

Oem Ref	Vehicle/Model	Engine
51065996023	V12 00 Z57 00 Z81 00 Z82 00 Z83 00	D0826 GFA02 D0226 MKF/MKH/MKFA/ MKFO/MKF-CA/USA D0224 M D0824 GF/GF01/02/03 KOOP-VW D0826 GF/GFA/ GF01/03/04/GFA01/03/04 KOOP-VW

\*impeller: ø 110 mm

Remarks

to fit water pumps:  
51065006432  
51065006443



WATER PUMP

**12.4043.00**

Replaced Old Famco No : FM194232100

Oem Ref	Vehicle/Model	Engine
51065006616	V42 00 V43 00 V53 00	D2866 LF26-28/32/36/37/41/43 D2876 LF04/05/07/11/20/21/22/24 D2876 LF12/13/25

\*impeller: ø 135 mm



Package Weight : **13,450 kg**  
Package Dimensions : **24x40x16 cm**



**02.1401.00**  
Ref : 51065030361



**09.2330.00**  
Ref : 51934100116



**09.4003.00**  
Ref : 51065200082



**01.2403.00**  
Ref : 51065065001  
Ø 135x16

REPAIR KIT

**15.4040.00**

Replaced Old Famco No : FM194001110

Oem Ref	Vehicle/Model	Engine
V 01 00		D 28 66 TUH/TUH 01/TUM
V 01 01		D 28 66 TUH01/IKARUS
V 05 00		D 28 65 LU 01/02/03
V 06 00		D 28 40 LF 01/04/06
V 10 00		D 28 66 LH 01/02
V 13 00		D 28 66 LUH/LXUH/LUH 05
V 14 00		D 28 65 LUH 02/03/05-09
V 15 00		D 28 66 LOH 20-26/30/31
V 16 00		E 28 66 DUH 01
Z 20 00		D 25 66 MKUL D 25 66 M/MF/MFR D 28 66 KUH D 28 66 FZR

\*impeller: ø 135 mm

Remarks

to fit water pumps:

51065006546 51065006526  
51065006426 51065009526  
51065006490 51065006492  
51065006616 51065009492



WATER PUMP

**12.4190.00**

Replaced Old Famco No : FM416806100

Oem Ref	Vehicle/Model	Engine
51065006698	M 012 00	BAUREIHE D/E08..
51065006674	M 228 00	D0836 LFL60-71/75-77
51065006668		
51065009698		
51065009674		
51065009668		

\*Hole: ø 18 mm

\*with metal gasket



Package Weight : **3,500 kg**  
Package Dimensions : **22,5x24,5x16 cm**



**03.1403.00**

Ref : 51065040035



**09.2330.00**

Ref : 51934100116



**09.4003.00**

Ref : 51065200082



**06.1401.00**

Ref : 51065060129

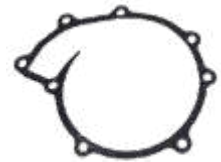

**09.5164.00**

Ref : 51069010196  
(Metal Gasket)

REPAIR KIT

**15.4150.00**

Replaced Old Famco No : FM416803110

Oem Ref	Vehicle/Model	Engine
V 55 00		D 2066 LF01 04/06/07/11-14
V 55 01		/21/22 31-35
V 55 03		D 2066 LF 34 (MOD UK)
V 65 00		D 2066 LF 34 (DAENISCHE
V 67 00		ARMEE)
V 70 00		D 2066 LOH 01/02/03/04/10
V 70 01		D 2676 LOH 01/02
V 73 00		D 2066 LFG 01
		D 2066 LFG 01 (MOD UK)
		D 2676 LF 01/11/12

\*with metal gasket

Remarks

to fit water pumps:

51065006680 51065007078  
51065007079 51065007064  
51065006651  
51065006679



WATER PUMP

**12.4200.00**

Replaced Old Famco No : FM416807100

Oem Ref	Vehicle/Model	Engine
51065006692	M 012 00	BAUREIHE D/E08..
51065006673	M 214 00	D0836 LOH51-58/60-68/ 70-76
51065009692		
51065009673		

\*Thread : M18 x 1,5

\*with metal gasket



Package Weight : **3,500 kg**  
Package Dimensions : **22,5x24,5x16 cm**



**03.1403.00**  
Ref : 51065040035



**09.2330.00**  
Ref : 51934100116



**09.4003.00**  
Ref : 51065200082



**06.1401.00**  
Ref : 51065060129



**09.5164.00**  
Ref : 51069010196  
(Metal Gasket)

REPAIR KIT

**15.4150.00**

Replaced Old Famco No : FM416803110

Oem Ref	Vehicle/Model	Engine
	V 55 00	D 2066 LF01 04/06/07/11-14
	V 55 01	/21/22 31-35
	V 55 03	D 2066 LF 34 (MOD UK)
	V 65 00	D 2066 LF 34 (DAENISCHE
	V 67 00	ARMEE)
	V 70 00	D 2066 LOH 01/02/03/04/10
	V 70 01	D 2676 LOH 01/02
	V 73 00	D 2066 LFG 01
		D 2066 LFG 01 (MOD UK)
		D 2676 LF 01/11/12

\*with metal gasket

Remarks

to fit water pumps:

51065006680 51065007078  
51065007079 51065007064  
51065006651  
51065006679



WATER PUMP

**12.4210.00**

Replaced Old Famco No : FM416808100

Oem Ref	Vehicle/Model	Engine
51065006691	M 012 00	BAUREIHE D/E08..
51065006701	M 214 00	D0836 LOH51-58/60-68/ 70-76

\*Thread : M16 x 1,5

\*with metal gasket



Package Weight : **3,500 kg**  
Package Dimensions : **22,5x24,5x16 cm**



**03.1403.00**  
Ref : 51065040035



**09.2330.00**  
Ref : 51934100116



**09.4003.00**  
Ref : 51065200082



**06.1401.00**  
Ref : 51065060129



**09.5164.00**  
Ref : 51069010196  
(Metal Gasket)

REPAIR KIT

**15.4150.00**

Replaced Old Famco No : FM416803110

Oem Ref	Vehicle/Model	Engine
	V 55 00	D 2066 LF01 04/06/07/11-14
	V 55 01	/21/22 31-35
	V 55 03	D 2066 LF 34 (MOD UK)
	V 65 00	D 2066 LF 34 (DAENISCHE
	V 67 00	ARMEE)
	V 70 00	D 2066 LOH 01/02/03/04/10
	V 70 01	D 2676 LOH 01/02
	V 73 00	D 2066 LFG 01
		D 2066 LFG 01 (MOD UK)
		D 2676 LF 01/11/12

\*with metal gasket

Remarks

to fit water pumps:

51065006680 51065007078  
51065007079 51065007064  
51065006651  
51065006679



WATER PUMP

**12.4130.00**

Replaced Old Famco No :

Oem Ref	Vehicle/Model	Engine
51065006479		
51065009479		

*\*impeller: ø 135 mm*



Package Weight : **12,450 kg**

Package Dimensions : **24x40x16 cm**



**01.3401.00**



**03.1403.00**  
Ref: 51065040035



**09.2330.00**  
Ref: 51934100116



**09.4003.00**  
Ref: 51065200082



**01.2403.00**  
Ref: 51065065001



**09.5168.00**

REPAIR KIT

**15.4230.00**

Replaced Old Famco No :

Oem Ref	Vehicle/Model	Engine
51065996025		BAUREIHE D28.. (V NEU)
51065996021		BAUREIHE D28.. (R+V ALT)
		D2866 LUH20/21/22/26
		D2866 LUH21 DEDIETRICH/LHB
		D2876 LUH01/02/03
		D2840 LXF/LF03/LF420/520
		D2840 LF20/21/23/24/27/28
		D2842 LF/LF01/LXF/ LF720-OEAF
		D2842 LF02
		D2842 LF10



WATER PUMP

**12.4220.00**

Replaced Old Famco No :

Oem Ref	Vehicle/Model	Engine
51065006624		M21200 - Baureihe
51065006560		D28... (R+V ALT)
51065006555		
51065009624		



Package Weight : **25,000 kg**  
Package Dimensions : **50x28x23 cm**



**01.3402.00**  
Ref : 51065030356  
51065033252



**01.2410.00**  
Ref : 51065066008



**08.1110.00**  
Ref : 51065120025



**09.5167.00**  
Ref : 51069010114



**09.1613.00**  
Ref : 51069040038



**16.4220.00**

REPAIR KIT

**15.4220.00**

Replaced Old Famco No :

Oem Ref	Vehicle/Model	Engine
51065996079		BAUREIHE D28...



WATER PUMP

**12.4131.00**

Replaced Old Famco No :

Oem Ref	Vehicle/Model	Engine
---------	---------------	--------

51065006548		
51065009548		

*\*impeller: ø 135 mm*



Package Weight : **13,700 kg**  
 Package Dimensions : **24x40x16 cm**



HOUSING

**11.4140.00**

Replaced Old Famco No :

Oem Ref	Vehicle/Model	Engine
---------	---------------	--------

51063305047	D2066	TGA
51063300068	D2676	TGL
		TGM
		TGS
		TGX



Package Weight : **7,500 kg**  
 Package Dimensions : **45x55x18 cm**





HOUSING

**11.4011.00**

Replaced Old Famco No : FM416800200

Oem Ref	Vehicle/Model	Engine
51063305048		D2066 LF01 BAUREIHE
51063305043		D28..
51063305033		
51063300056		
51063305026		
51063305033		
51063300041		
51063305019		
51063300027		
51063300031		



Package Weight : **7,500 kg**  
Package Dimensions : **45x55x18 cm**



HOUSING

**11.4010.00**

Replaced Old Famco No : FM416801200

Oem Ref	Vehicle/Model	Engine
51063305041		EURO 4
51063305040		EURO 5
51063300055		
51063300054		
51063305032		
51063305031		
51063305035		
51063305034		
51063300049		
51063300048		
51063305024		
51063305023		



Package Weight : **7,500 kg**  
Package Dimensions : **45x55x18 cm**



VOLVO

SCANIA

MERCEDES-BENZ

MAN

DAF

RENAULT

IVECO

OTHERS

VOLVO

SCANIA

MERCEDES-BENZ

MAN

DAF

RENAULT

IVECO

OTHERS

FOR DAF



[www.famco.com.tr](http://www.famco.com.tr)



WATER PUMP

**12.5090.00**

Replaced Old Famco No : FMXF9501000



Oem Ref	Vehicle/Model	Engine
1609871	75 CF	6-8-11 Ltr. engines
0683586	85 CF	
0683225	95 XF	
0683386	95 XF 530	
0683386	F 75	
0683586R	F 95	
1609871R	LF 45	
0683225R	XF 95	



Package Weight : **11,850 kg**  
Package Dimensions : **28x35x18 cm**



**03.1501.00**  
Ref : 1323914



**03.2503.00**  
Ref : 1450190



**09.2303.00**  
Ref : 1256792



**09.5150.00**  
Ref : 0753672



**01.2502.00**  
Ref : 0272508

REPAIR KIT

**15.5090.00**

Replaced Old Famco No : FMXF9501010



Oem Ref	Vehicle/Model	Engine
	75 CF	6-8-11 Ltr. engines
	85 CF	
	95 XF	
	95 XF 530	
	F 75	
	F 95	
	LF 45	
	XF 95	

Remarks

to fit water pumps:

1609871  
0683579  
0683586

WATER PUMP

**12.5050.00**

Replaced Old Famco No : FM950001000

Oem Ref	Vehicle/Model	Engine
0682968	F 80	WS242L
0682258	F 85	WS268L
0681653	F 95	WS295
0682968R		WS315G
0682258R		

\*flange height : 136,5 mm



Package Weight : **11,400 kg**  
 Package Dimensions : **28x35x18 cm**



**02.2501.00**  
 Ref : 0384714



**03.2503.00**  
 Ref : 1450190



**09.5147.00**  
 Ref : 0753673



**09.4001.00**  
 Ref : 1285773



**16.5050.00**

REPAIR KIT

**15.5050.00**

Replaced Old Famco No : FM950001010

Oem Ref	Vehicle/Model	Engine
	F 80	WS242L
	F 85	WS268L
	F 95	WS295
	1160 AVM	WS315G
	KD	WS315L
	SB 3000	
	SBR 3000	

Remarks

to fit water pumps:  
 0682968  
 0682258  
 0682980



WATER PUMP

**12.5051.00**

Replaced Old Famco No : FM950011000

Oem Ref	Vehicle/Model	Engine
0682980	F 85	WS315L
0682980R	F 95	
0683141	1160 AVM	
0683141R	KD	
	SB 3000	
	SBR 3000	

\*flange height : 145,5 mm



Package Weight : **11,350 kg**  
Package Dimensions : **28x35x18 cm**



**02.2502.00**  
Ref : 1257162



**03.2503.00**  
Ref : 1450190



**09.2303.00**  
Ref : 1256792



**09.4001.00**  
Ref : 1285773



**01.2502.00**  
Ref : 0272508

REPAIR KIT

**15.5050.00**

Replaced Old Famco No : FM950001010

Oem Ref	Vehicle/Model	Engine
	F 80	WS242L
	F 85	WS268L
	F 95	WS295
	1160 AVM	WS315G
	KD	WS315L
	SB 3000	
	SBR 3000	

Remarks

to fit water pumps:  
0682968  
0682258  
0682980



WATER PUMP

**12.5020.00**

Replaced Old Famco No : FM280001000

Oem Ref	Vehicle/Model	Engine
0682262	BUS	DKS 1160
0680156	F 2800	DKSE 1160
0682262R	F 2900	DKST 1160
0680156R	F 3200	DKTD 1160
	F 3300	
	F 3600	With Visco Drive Fan
	N 2800	
	TT 2100	



Package Weight : **12,200 kg**  
 Package Dimensions : **28x40x18 cm**



**03.2501.00**  
 Ref : 0653235



**09.5146.00**  
 Ref : 0516726



**09.5145.00**  
 Ref : 1244482



**01.2501.00**  
 Ref : 0680191



**16.5020.00**

REPAIR KIT

**15.5020.00**

Replaced Old Famco No : FM280001010

Oem Ref	Vehicle/Model	Engine
	BUS	DKS 1160
	F 2800	DKSE 1160
	F 2900	DKST 1160
	F 3200	DKTD 1160
	F 3300	With Visco Drive Fan
	F 3600	
	N 2800	
	TT 2100	



WATER PUMP

**12.5040.00**

Replaced Old Famco No : FM330001000

Oem Ref	Vehicle/Model	Engine
0682260	F 2800	DKS 1160
0517097	F 2900	DKSE 1160
0506109	F 3200	DKST 1160
0506109	F 3300	DKTD 1160
0682260R	F 3600	
	N 2800	With Electric Fan
	TT 2100	



Package Weight : **12,300 kg**  
Package Dimensions : **28,5x38x22 cm**



**03.2502.00**  
Ref : 0516728



**09.2303.00**  
Ref : 1256792



**09.4001.00**  
Ref : 1285773



**01.2501.00**  
Ref : 0680191



**16.5020.00**

REPAIR KIT

**15.5040.00**

Replaced Old Famco No : FM330001010

Oem Ref	Vehicle/Model	Engine
	F 2800	DKS 1160
	F 2900	DKSE 1160
	F 3200	DKST 1160
	F 3300	DKTD 1160
	F 3600	
	N 2800	With Electric Fan
	TT 2100	



WATER PUMP

**12.5080.00**

Replaced Old Famco No : FMCF8501000

Oem Ref	Vehicle/Model	Engine
0683579	85 CF	6-8-11 Ltr. engines
1609853	95 XF	
1399150	CF 85	
0683579R	CF 85 IV	
	XF 95	
	YTZ 95	



Package Weight : **10,850 kg**  
 Package Dimensions : **28x35x18 cm**



**03.1501.00**  
 Ref : 1323914



**03.2503.00**  
 Ref : 1450190



**09.2303.00**  
 Ref : 1256792



**09.4001.00**  
 Ref : 1285773



**06.1501.00**  
 Ref : 1282029

REPAIR KIT

**15.5080.00**

Replaced Old Famco No : FMCF8501010

Oem Ref	Vehicle/Model	Engine
	85 CF	6-8-11 Ltr. engines
	95 XF	
	CF 85	
	CF 85 IV	
	XF 95	
	YTZ 95	

Remarks

to fit water pumps:

1609871  
 0683579  
 0683586



WATER PUMP

**12.5010.00**

Replaced Old Famco No : FMXF1051000

Oem Ref	Vehicle/Model	Engine
1828162	1260V5	
1778280	1290MX	
1664762	CF85	
1738991	CF85II	
1639196	CF85IV	
1649082	CF85V	
1644762	FTSXF105	
1828162R	FTTXF105	
1778280R	GIN85MX	
1664762R	MX	
	MX EU	
	MX EU5	
	SB4000	
	SBR4000	
	TATRA KC16	
	TATRA T158	
	XF95	
	XF95II	
	XF105	



Package Weight : **3,400 kg**  
Package Dimensions : **19x20x18 cm**



**02.1502.00**  
Ref : 1665605



**09.2333.00**



**09.4003.00**



**06.1503.00**

REPAIR KIT

**15.5010.00**

Replaced Old Famco No : FMXF1051010

Oem Ref	Vehicle/Model	Engine
	CF 85 IV	
	F 5 - F 27	
	XF 105	
	XF 95	



WATER PUMP

**12.5030.00**

Replaced Old Famco No : FM750001000

Oem Ref	Vehicle/Model	Engine
0683338 (0683338R)	F75 75CF	



Package Weight : **11,150 kg**  
 Package Dimensions : **28x35x18 cm**



**03.1501.00**  
 Ref: 1323914



**03.2503.00**  
 Ref: 1450190



**09.2303.00**  
 Ref: 1256792

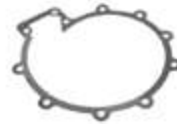

**09.5149.00**



**06.1501.00**  
 Ref: 1282029

REPAIR KIT

**15.5030.00**

Replaced Old Famco No : FM750001010

Oem Ref	Vehicle/Model	Engine
	75 CF 95 XF 530 CF 75 CF 75 IV	6-8-11 Ltr. engines

Remarks

to fit water pumps:

0682747 1609854  
 0683580 1441060  
 0683338  
 1734841



WATER PUMP

**12.5070.00**

Replaced Old Famco No : FMCF7501000

Oem Ref	Vehicle/Model	Engine
0683580	75 CF	6-8-11 Ltr. engines
1609854	95 XF	
1441060	CF 75	
(1609854R)	CF 75 IV	
(1441060R)		
(0683580R)		



Package Weight : **11,000 kg**  
Package Dimensions : **28x35x18 cm**



**03.1501.00**  
Ref : 1323914



**03.2503.00**  
Ref : 1450190



**09.2303.00**  
Ref : 1256792



**09.5149.00**  
Ref : 1205399



**06.1501.00**  
Ref : 1282029

REPAIR KIT

**15.5030.00**

Replaced Old Famco No : FM750001010

Oem Ref	Vehicle/Model	Engine
	75 CF	6-8-11 Ltr. engines
	95 XF 530	
	CF 75	
	CF 75 IV	



Remarks

to fit water pumps:

0682747 1609854  
0683580 1441060  
0683338  
1734841

WATER PUMP

**12.5071.00**

Replaced Old Famco No : FMCF7511000

Oem Ref	Vehicle/Model	Engine
1734841	CF 75 IV	
1734841R		



Package Weight : **11,100 kg**  
 Package Dimensions : **28x40x18 cm**



**03.1501.00**  
 Ref : 1323914



**03.2503.00**  
 Ref : 1450190



**09.2303.00**  
 Ref : 1256792



**09.4001.00**  
 Ref : 1285773



**06.1501.00**  
 Ref : 1282029

REPAIR KIT

**15.5030.00**

Replaced Old Famco No : FM750001010

Oem Ref	Vehicle/Model	Engine
75 CF	95 XF 530	6-8-11 Ltr. engines
CF 75		
CF 75 IV		

Remarks

to fit water pumps:

0682747 1609854  
 0683580 1441060  
 0683338  
 1734841



WATER PUMP

**12.7080.00**

Replaced Old Famco No : FMCF6501000

Oem Ref	Vehicle/Model	Engine
1399689	CF65	
1399689R	CF65II	
CBU 2714	CF65IV	
CBU 2148	LF45	
CBU 1909	LF45IV	
CBU 1131	LF55	
(CBU 2396R)	LF55IV	
CBU 2396		



Package Weight : **2,600 kg**  
Package Dimensions : **17,5x18,5x16 cm**



**02.1501.00**



**09.2334.00**



**09.4002.00**



**06.1502.00**

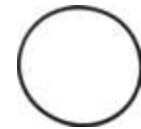

**09.1536.00**  
Ref : 1399688

REPAIR KIT

**15.7080.00**

Replaced Old Famco No : FMCF6501010

Oem Ref	Vehicle/Model	Engine
	CF65	
	CF65II	
	CF65IV	
	LF45	
	LF45IV	
	LF55	
	LF55IV	



WATER PUMP

**12.5100.00**

Replaced Old Famco No : FMXF1061000

Oem Ref	Vehicle/Model	Engine
2104575	MX-13	
1944842		

\*impeller:  $\varnothing$  116 mm

Package Weight : **3,500 kg**  
 Package Dimensions : **19x20x18 cm**



WATER PUMP

**12.5101.00**

Replaced Old Famco No :

Oem Ref	Vehicle/Model	Engine
2042162		
1912939		

\*impeller:  $\varnothing$  113 mm

Package Weight : **3,500 kg**  
 Package Dimensions : **19x20x18 cm**



WATER PUMP

# 12.5102.00

Replaced Old Famco No :

Oem Ref	Vehicle/Model	Engine
2104579		
1949545		

\*impeller: ø 113 mm



Package Weight : **3,500 kg**  
Package Dimensions : **19x20x18 cm**



WATER PUMP

# 12.5103.00

Replaced Old Famco No :

Oem Ref	Vehicle/Model	Engine
2104580		

\*impeller: ø 106 mm



Package Weight : **3,500 kg**  
Package Dimensions : **19x20x18 cm**



WATER PUMP

**12.5104.00**

Replaced Old Famco No :

Oem Ref	Vehicle/Model	Engine
2042161		
1912940		

\*impeller: ø 106 mm

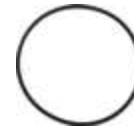

Package Weight : **3,500 kg**  
 Package Dimensions : **19x20x18 cm**

**02.1503.00****09.2343.00****09.4003.00****09.1571.00****08.1501.00****06.1505.00**  
Ø 116mm**06.1506.00**  
Ø 113mm**06.1507.00**  
Ø 106mm**08.1502.00**



FUEL FEED PUMP

# 32.5010.00

Replaced Old Famco No :

Oem Ref	Vehicle/Model	Engine
1939435	XF 106	Euro 6



Package Weight : **0,600 kg**  
Package Dimensions : **10x10x10 cm**



FUEL FEED PUMP

# 32.5020.00

Replaced Old Famco No :

Oem Ref	Vehicle/Model	Engine
1797650	85CF	
1695495	XF 95 XF105	



Package Weight : **0,600 kg**  
Package Dimensions : **10x10x10 cm**



WATER PUMP

**12.5060.51**

Replaced Old Famco No :

Oem Ref	Vehicle/Model	Engine
Fit for the below Oem Ref:	CF EURO 6 XF EURO 6	MX 11
2104574		
1922223		
1923223		
1934326		
1995152		

\*impeller:  $\varnothing$  116 mm

Package Weight : **5,900 kg**  
 Package Dimensions : **21x25x22 cm**



WATER PUMP

**12.5061.51**

Replaced Old Famco No :

Oem Ref	Vehicle/Model	Engine
Fit for the below Oem Ref:	CF EURO 6 XF EURO 6	MX 13
2104577		
1949539		

\*impeller:  $\varnothing$  113 mm

Package Weight : **5,900 kg**  
 Package Dimensions : **21x25x18 cm**



WATER PUMP

**12.5062.51**

Replaced Old Famco No :

Oem Ref	Vehicle/Model	Engine
Fit for the below Oem Ref:	CF EURO 6 XF EURO 6	MX13
2104578 1949540		

\*impeller:  $\varnothing$  106 mm



Package Weight : **5,900 kg**  
Package Dimensions : **21x25x22 cm**



VOLVO

SCANIA

MERCEDES-BENZ

MAN

DAF

RENAULT

IVECO

OTHERS

FOR RENAULT

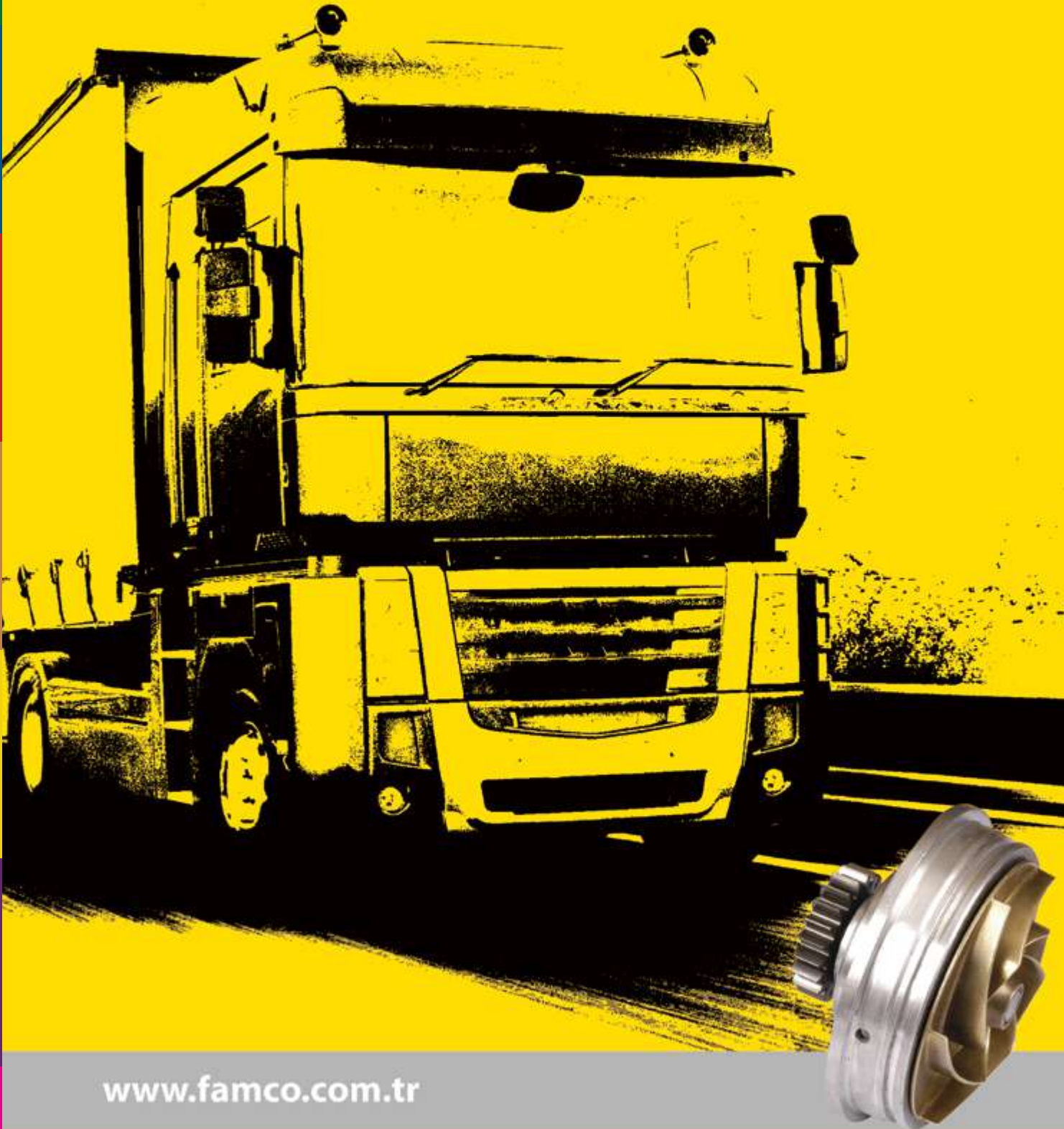

[www.famco.com.tr](http://www.famco.com.tr)

WATER PUMP

**12.6041.00**

Replaced Old Famco No : FM042001000

Oem Ref	Vehicle/Model	Engine
5001857427 5001858484	PREMIUM TR 4x2 PREMIUM (FAB 22 E / H / J / Q / R) PREMIUM TRACTEUR 4x2 (FAB 22 CC) PREMIUM (FAB 22 EE / HA / HB / JJ / QQ / RR) PREMIUM PR 4x2 (FAB 22 AA / AB) KERAX (FAB 33 AA - SS) PREMIUM 22 C 071	FAB22CC



Package Weight : **2,250 kg**  
Package Dimensions : **17,5x18,5x16 cm**



**03.6603.00**



**09.2336.00**



**05.1601.00**



**16.6041.00**



**09.5152.00**  
Ref : 5010550496

REPAIR KIT

**15.6041.00**

Replaced Old Famco No : FM042001010

Oem Ref	Vehicle/Model	Engine
	PREMIUM TR 4x2 PREMIUM (FAB 22 E / H / J / Q / R) PREMIUM TRACTEUR 4x2 (FAB 22 CC) PREMIUM (FAB 22 EE / HA / HB / JJ / QQ / RR) PREMIUM PR 4x2 (FAB 22 AA / AB) KERAX (FAB 33 AA - SS) PREMIUM 22 C 071	FAB22CC



WATER PUMP

**12.1140.00**

Replaced Old Famco No : FM050001000

Oem Ref	Vehicle/Model	Engine
7420734268	MAGNUM	DXI 12
5001866278		DXI 13



Package Weight : **4,600 kg**  
 Package Dimensions : **17,5x18,5x16 cm**

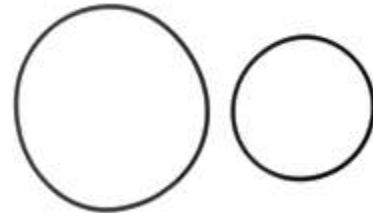

**03.6105.00**  
 Ref : 748170309



**09.2324.00**  
 Ref : 748170308



**09.4004.00**  
 Ref : 7401676432



**06.1107.00**  
 Ref : 7420431128

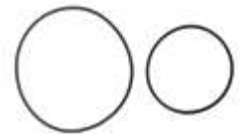

**16.1120.00**

REPAIR KIT

**15.1140.00**

Replaced Old Famco No : FM050001010

Oem Ref	Vehicle/Model	Engine
	MAGNUM	DXI 12 DXI 13



WATER PUMP

**12.6011.00**

Replaced Old Famco No : FM032001000

Oem Ref	Vehicle/Model	Engine
5010330029	MAXTER	MIDR 062045/141
5001837309	G 340 TI 6x6	MIDR 062045E
7485021193	G 340 TI TR 18 T	
7422884619	PREMIUM TR 4x2	
	PREMIUM 6x2 & 6x2/4	
	MAXTER 4x2 - 4x4	
	PREMIUM PR 4x2	
	KERAX	
	PREMIUM 260 SP	
	PREMIUM TR 4x2	
	PREMIUM AB 22 E / H	
	/ J / Q / R	
	PREMIUM PR 4x2 (FAB 22A)	
	KERAX (FAB 33A)	



Package Weight : **4,200 kg**  
Package Dimensions : **17,5x18,5x16 cm**



**03.6601.00**  
Ref : 5000681344



**09.2337.00**  
Ref : 5010359555



**09.4003.00**  
Ref : 5010477185



**01.2601.00**  
Ref : 5000694946



**16.6011.00**

REPAIR KIT

**15.6011.00**

Replaced Old Famco No : FM032001010

Oem Ref	Vehicle/Model	Engine
	MAXTER	MIDR 062045/141
	G 340 TI 6x6	MIDR 062045E
	G 340 TI TR 18 T	
	PREMIUM TR 4x2	
	PREMIUM 6x2 & 6x2/4	
	MAXTER 4x2 - 4x4	
	PREMIUM PR 4x2	
	KERAX	
	PREMIUM 260 SP	
	PREMIUM TR 4x2	
	PREMIUM AB 22 E / H	
	/ J / Q / R	
	PREMIUM PR 4x2 (FAB 22A)	
	KERAX (FAB 33A)	



WATER PUMP

**12.6022.00**

Replaced Old Famco No : FM032011000

Oem Ref	Vehicle/Model	Engine
5000670157	G 260 / 290	MIDR 062045 E
5001837298	C 260 / 290 C 210, CLR 220 G 210 / 230 R 310 / 330 / 340 / 365 G 320 "R", R340TI C230 / 280 / 300 / 340TI / CCH300 MAXTER 6x4 - 8x4 "R", R340TI G 230 / 270 SP G 220 / 270 BOM "G" MANAGER 4x2 except / außer: G 300 "G" MANAGER 6x2 - 6x4 G 340TI 6x6 G 340TI 4x4 G 340TI, TR 18 T MAXTER 4x2 - 4x4	MIDR 062045 E / 3



Package Weight : **3,800 kg**  
Package Dimensions : **17,5x18,5x16 cm**



**03.6602.00**



**03.2601.00**



**09.4003.00**  
Ref : 5010477185



**01.2605.00**  
Ref : 5000663118

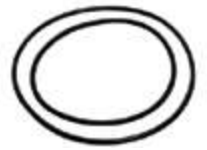

**16.6022.00**

REPAIR KIT

**15.6022.00**

Replaced Old Famco No : FM032011010

Oem Ref	Vehicle/Model	Engine
	G 260 / 290 C 260 / 290 C 210, CLR 220 G 210 / 230 R 310 / 330 / 340 / 365 G 320 "R", R340TI C230 / 280 / 300 / 340TI / CCH300 MAXTER 6x4 - 8x4 "R", R340TI G 230 / 270 SP G 220 / 270 BOM "G" MANAGER 4x2 except / außer: G 300 "G" MANAGER	MIDR 062045 E MIDR 062045 E / 3





WATER PUMP

**12.1020.00**

Replaced Old Famco No : FM044001000

Oem Ref	Vehicle/Model	Engine
7421615952	PREMIUM TR	TR FAB-27JC/TC
7420744940	PREMIUM PR	PR FAB-27RC/SC
7485000763	KERAX DXI	DXI 11-FAB-34.C/34.F
7485013068	MAGNUM DXI 13	DXI 13 FAB 17JE/RE/SE/TE
7422197707		TR FAB-24.F/25.C PR FAB-24.F/25.C FAB 36 D / 36 E FAB 17 JF / RF / SF / TF



Package Weight : **2,800 kg**  
Package Dimensions : **22x32x14 cm**



**03.1601.00**



**09.2325.00**



**09.4002.00**



**06.1109.00**



**04.3101.00**  
OEM Ref: 7420707160  
7421617479  
Diameter Ø148 mm

REPAIR KIT

**15.1020.00**

Replaced Old Famco No : FM044001010

Oem Ref	Vehicle/Model	Engine
	PREMIUM TR	TR FAB-27JC/TC
	PREMIUM PR	PR FAB-27RC/SC
	KERAX DXI	DXI 11-FAB-34.C/34.F
	MAGNUM DXI 13	DXI 13 FAB 17JE/RE/SE/TE
		TR FAB-24.F/25.C PR FAB-24.F/25.C FAB 36 D / 36 E FAB 17 JF / RF / SF / TF



WATER PUMP

**10.1020.00**

Replaced Old Famco No : FM044003000



Package Weight : **5,350 kg**  
 Package Dimensions : **23x35x23 cm**

HOUSING

**11.1020.00**

Replaced Old Famco No : FM044002000



Package Weight : **2,800 kg**  
 Package Dimensions : **22x35x14 cm**

WATER PUMP

**10.1030.00**

Replaced Old Famco No : FM044013000

Oem Ref	Vehicle/Model	Engine
	PREMIUM PR	TR FAB-27JC/TC
	KERAX	PR FAB-27RC/SC
	PREMIUM TR	DXI 11-FAB-34.C/34.F
	KERAX 8X4 SAMPT	TR FAB-24.F/25.C
	KERAX NAMSA	PR FAB-24.F/25.C (RESEAU)



Package Weight : **7,800 kg**  
Package Dimensions : **28x49x23 cm**



HOUSING

**11.1030.00**

Replaced Old Famco No : FM044012000

Oem Ref	Vehicle/Model	Engine
7420539530	C-Truck Kerax NAMSA (RESEAU) Kerax SEA Kerax 8x4 SAMPT (RESEAU) Kerax DXi 11 FAB-34.C/34.F K-Truck Premium PR FAB-24.F/25.C Premium PR FAB-27RC/SC Premium TR FAB-24.F/25.C Premium TR FAB-27JC/TC	



Package Weight : **5,150 kg**  
Package Dimensions : **27x49,5x15,5 cm**



WATER PUMP

**12.3230.00**

Replaced Old Famco No : FM256601000

Oem Ref	Vehicle/Model	Engine
5000286186	TYPE ALL MODELS WITH ENGINE	D 25 66 D 25 30 D 25 38



Package Weight : **11,600 kg**  
Package Dimensions : **24x40x16 cm**

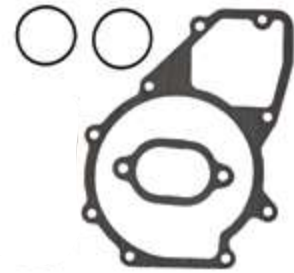

**03.1403.00**



**09.2328.00**



**09.4004.00**  
Ref : 7401676432



**01.2305.00**



**16.3230.00**

REPAIR KIT

**15.3230.00**

Replaced Old Famco No : FM256601010

Oem Ref	Vehicle/Model	Engine
	TYPE ALL MODELS WITH ENGINE	D 25 66 D 25 30 D 25 38

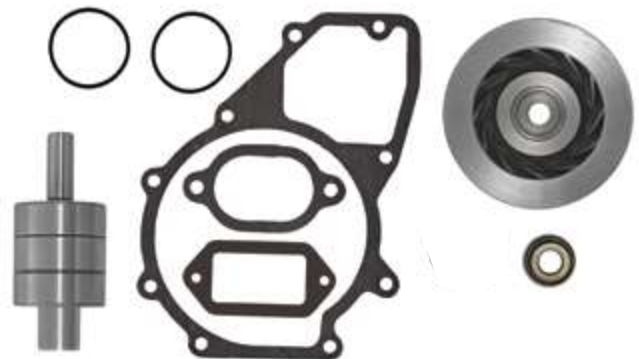

WATER PUMP

**12.6031.00**

Replaced Old Famco No : FM034011000

Oem Ref	Vehicle/Model	Engine
5010248921 5001837322	AE 380 / 385 TI / 420 TI / 500 / 520 CBH / CLM 320 / 385 „R” AE Magnum 390 / 420 TI / 430 / 470 / 560	MDR 16/03/79 MIDR

\*Hole: ø 14,5 mm



Package Weight : **6,450 kg**  
Package Dimensions : **22,5x24,5x16 cm**



**03.2602.00**  
Ref : 0000773798



**01.2602.00**  
Ref : 5000666307



**09.4003.00**  
Ref : 5010477185



**09.5151.00**  
Ref : 5000678715  
(Paper Gasket)

REPAIR KIT

**15.6032.00**

Replaced Old Famco No : FM034001010

Oem Ref	Vehicle/Model	Engine
	TR / GR 305 GR / TR 280 GRH / TRH 305 R310 4X2 GBH / TBH 280 GBH 260 / 280 6X6 GBH 260 / 280 6X4 R310 6X4 JSQ GLM / TLM 280 R 310 / 330 / 340 / 365 CBH / CLM 280 / 340 AE 380 / 385TI / 420TI / 500 / 520 CBH / CLM 320 / 385	MDR 16/03/79 MIDR

Remarks  
to fit water pumps:  
5010248921  
5001837322  
5010323187  
5001837314



WATER PUMP

**12.6032.00**

Replaced Old Famco No : FM034001000



Oem Ref	Vehicle/Model	Engine
5010323187	TR / GR 305	MDR 16/03/79 MIDR
5001837314	GR / TR 280 GRH / TRH 305 R310 4X2 GBH / TBH 280 GBH 260 / 280 6X6 GBH 260 / 280 6X4 R310 6X4 JSQ GLM / TLM 280 R 310 / 330 / 340 / 365 CBH / CLM 280 / 340 AE 380 / 385TI / 420TI / 500 / 520 „R“ CBH / CLM 320 / 385 „R“	

\*Hole: ø 12,5 mm



Package Weight : **6,450 kg**  
Package Dimensions : **22,5x24,5x16 cm**



**03.2602.00**  
Ref : 0000773798



**01.2602.00**  
Ref : 5000666307



**09.4003.00**  
Ref : 5010477185



**09.5151.00**  
Ref : 5000678715  
(Paper Gasket)

REPAIR KIT

**15.6032.00**

Replaced Old Famco No : FM034001010

Oem Ref	Vehicle/Model	Engine
	TR / GR 305 GR / TR 280 GRH / TRH 305 R310 4X2 GBH / TBH 280 GBH 260 / 280 6X6 GBH 260 / 280 6X4 R310 6X4 JSQ GLM / TLM 280 R 310 / 330 / 340 / 365 CBH / CLM 280 / 340 AE 380 / 385TI / 420TI / 500 / 520 CBH / CLM 320 / 385	MDR 16/03/79 MIDR

Remarks  
to fit water pumps:

5010248921  
5001837322  
5010323187  
5001837314



WATER PUMP

**12.6090.00**

Replaced Old Famco No : FM046011000

Oem Ref	Vehicle/Model	Engine
---------	---------------	--------

7421974078	C-Truck	
7421969188	Kerax SEA	
7421812242	Kerax 8x4 SAMPT (RESEAU)	
7421648716	Kerax DXi 11 FAB-34.C/34.F	
7421072414	K-Truck	
	Premium PR FAB-24.F/25.C	
	Premium TR FAB-24.F/25.C	
	T-Truck	



Package Weight : **6,150 kg**  
Package Dimensions : **21x31x18 cm**



WATER PUMP

**12.6030.00**

Replaced Old Famco No : FM046021000

Oem Ref	Vehicle/Model	Engine
---------	---------------	--------

7421960480	C-Truck	
7421969184	Kerax DXi 13 FAB-36.D/36.E	
7421648714	K-Truck	
7421072413	Magnum DXi 13 FAB-17JF/RF/SF/TF	
	T-Truck	



Package Weight : **6,200 kg**  
Package Dimensions : **21x31x18 cm**



WATER PUMP

**12.6040.00**

Replaced Old Famco No : FM046031000

Oem Ref	Vehicle/Model	Engine
7421960482	C-Truck	
7421814005	Kerax DXi 13FAB-	
7421648715	36.D/36.E	
7421072412	K-Truck	
	Magnum DXi 13 FAB-	
	17JF/RF/SF/TF	
	T-Truck	



Package Weight : **5,550 kg**  
 Package Dimensions : **21x31x18 cm**



WATER PUMP

**10.6030.00**

Replaced Old Famco No : FM046023000

Oem Ref	Vehicle/Model	Engine
7421941086	FH	D 13 C
7421648908	FH (4)	Euro 5
	FM	
	FM (4)	



Package Weight : **8,650 kg**  
 Package Dimensions : **23x35x23 cm**





WATER PUMP

**10.6040.00**

Replaced Old Famco No : FM046033000

Oem Ref	Vehicle/Model	Engine
7421648910	FH FH (4) FM FM (4)	D 13 C / K Euro 5



Package Weight : **7,850 kg**  
Package Dimensions : **23x35x23 cm**



**09.1101.00**  
Ref : 741676554

**09.1105.00**

**09.1103.00**  
Ref : 743979940

HOUSING

**11.6050.00**

Replaced Old Famco No : FM050002000

Oem Ref	Vehicle/Model	Engine
7420713789	MAGNUM	DXI 12 DXI 13



Package Weight : **8,600 kg**  
Package Dimensions : **28x28x24 cm**



WATER PUMP

## 12.6090.51

Replaced Old Famco No :

Oem Ref	Vehicle/Model	Engine
Fit for the below Oem Ref:	C-Truck Kerax SEA Kerax 8x4 SAMPT (RESEAU)	
7421974078	Kerax DXi 11 FAB-	
7421969188	34.C/34.F	
7421812242	K-Truck	
7421648716	Premium PR FAB-	
7421072414	24.F/25.C Premium TR FAB-	
	24.F/25.C T-Truck	



Package Weight : **6,150 kg**  
Package Dimensions : **21x31x18 cm**



WATER PUMP

## 12.6030.51

Replaced Old Famco No :

Oem Ref	Vehicle/Model	Engine
Fit for the below Oem Ref:	C-Truck Kerax DXi 13 FAB-	
7421960480	36.D/36.E	
7421969184	K-Truck	
7421648714	Magnum DXi 13 FAB-	
7421072413	17JF/RF/SF/TF T-Truck	



Package Weight : **6,200 kg**  
Package Dimensions : **21x31x18 cm**



WATER PUMP

**12.6040.51**

Replaced Old Famco No :

Oem Ref	Vehicle/Model	Engine
Fit for the below Oem Ref:	C-Truck Kerax DXi 13FAB- 36.D/36.E K-Truck	
7421960482	Magnum DXi 13 FAB-	
7421814005	17JF/RF/SF/TF	
7421648715	T-Truck	
7421072412		



Package Weight : **5,550 kg**  
Package Dimensions : **21x31x18 cm**



WATER PUMP

**10.6030.51**

Replaced Old Famco No :

Oem Ref	Vehicle/Model	Engine
Fit for the below Oem Ref:	FH FH (4) FM FM (4)	D 13 C Euro 5
7421941086		
7421648908		



Package Weight : **8,650 kg**  
Package Dimensions : **23x35x23 cm**



WATER PUMP

**10.6040.51**

Replaced Old Famco No :

Oem Ref	Vehicle/Model	Engine
Fit for the below Oem Ref:	FH FH (4) FM FM (4)	D 13 C / K Euro 5
7421648910		



Package Weight : **7,850 kg**  
 Package Dimensions : **23x35x23 cm**



**09.1101.00**  
 Ref : 741676554



**09.1105.00**



**09.1103.00**  
 Ref : 743979940

WATER PUMP

**12.6140.00**

Replaced Old Famco No : FM053001000

Oem Ref	Vehicle/Model	Engine
7420997650	Caesar	
7485003894	GBH/TBH	
7420834409	Egyptian Army	
7485009894	Midlum DXi 5/7	
0002201138	FAB-44.A/B/E/L/M	
	Midlum Security /	
	Mids MRAP	
	Premium DXi 7	
	FAB-29.B/29.G	
	PT Pindad	
	Sherpa 3 NAMSA	
	SherpaLight 84DD	

\*with metal gasket



Package Weight : **4,350 kg**  
Package Dimensions : **27x27x16 cm**



**02.1101.00**



**09.2342.00**



**09.4002.00**



**01.2102.00**



**09.5104.00**  
Ref : 7421632658  
7420793735  
(Metal Gasket)

REPAIR KIT

**15.6140.00**

Replaced Old Famco No : FM053001010

Oem Ref	Vehicle/Model	Engine
	Caesar	
	GBH/TBH	
	Egyptian Army	
	Midlum DXi 5/7	
	FAB-44.A/B/E/L/M	
	Midlum Security /	
	Mids MRAP	
	Premium DXi 7	
	FAB-29.B/29.G	
	PT Pindad	
	Sherpa 3 NAMSA	
	SherpaLight 84DD	

\*with metal gasket



WATER PUMP

**12.6150.00**

Replaced Old Famco No : FM053021000



Oem Ref	Vehicle/Model	Engine
	Caesar	
	GBH/TBH	
	Egyptian Army	
	Midlum DXi 5/7	
	FAB-44.A/B/E/L/M	
	Midlum Security /	
	Mids MRAP	
	Premium DXi 7	
	FAB-29.B/29.G	
	PT Pindad	
	Sherpa 3 NAMSA	
	SherpaLight 84DD	

*\*with metal gasket kit*



Package Weight : **4,600 kg**  
 Package Dimensions : **27x27x16 cm**



**02.1101.00**



**09.2342.00**



**09.4002.00**



**01.2102.00**



**09.1561.00**  
 Ref : 7421364517

GASKET KIT

**16.6140.00**

Replaced Old Famco No : FM053001009

Oem Ref	Vehicle/Model	Engine
	D5 E	TAD 530 GE
	D5 F	TAD 531 GE
	D7 E	TAD 532 GE
	FE	TAD 560 VE
	FL	TAD 561 VE
	B5LH	TAD 562 VE
	B5RH	TAD 563 VE
	B6R	TAD 564 VE
	B7R	TAD 565 VE
	DE	TAD 720 GE
		TAD 730 GE
		TAD 731 GE

*\*with metal gasket*



WATER PUMP

**12.7100.00**

Replaced Old Famco No : FM846051000

Oem Ref	Vehicle/Model	Engine
5001857981		



Package Weight : **3,700 kg**  
 Package Dimensions : **19x20x18 cm**



**02.1702.00**



**09.2338.00**



**09.4003.00**  
 Ref : 5010477185



**06.1702.00**

REPAIR KIT

**15.7070.00**

Replaced Old Famco No : FM846021010

Oem Ref	Vehicle/Model	Engine
---------	---------------	--------



WATER PUMP

**12.6120.00**

Replaced Old Famco No : FM048001000



Oem Ref	Vehicle/Model	Engine
7485003149	Magnum E-Tech	
5001875237	400/440/480	
5200537899	Sisu	
5200551856	Sisu 6x4 TRPC 50T AF	

*\*with pulley*



Package Weight : **12,350 kg**  
 Package Dimensions : **21x25x22 cm**



**01.3601.00**  
 Ref : 5001858765

**09.2318.00**  
 Ref : 5001858748

**08.1601.00**  
 Ref : 5001858749

**09.5153.00**  
 Ref : 5001854959

**09.5154.00**

**16.6120.00**

WATER PUMP

**12.6121.00**

Replaced Old Famco No : FM048011000

Oem Ref	Vehicle/Model	Engine
5010284179		
5001837331		
5001863754		
5010438102		

*\*without pulley*



Package Weight : **6,500 kg**  
 Package Dimensions : **21x25x22 cm**





WATER PUMP

**12.6111.00**

Replaced Old Famco No :

Oem Ref	Vehicle/Model	Engine
7422485206	CS200/250/300	
5010450892	M/S150/180/210/220/ 230TI/250	
5001865041	ME/SE/CE160/180/210 Midlum 42B3/4-44T/V/C.45 Midlum FAB-42B1/2-43C1/ 2-43T/V Midlum FAB-42US-44US-45US Midlum 4x4 47XA/47XC Midlum CCF 4x4 FAB-47XF Midlum Export FAB-43E1-43E2 MS200/250/300	

\*ø 44x11 mm

\*with stopper

\*with metal gasket



Package Weight : **6,250 kg**  
Package Dimensions : **24,5x28,5x14,5 cm**



WATER PUMP

**12.6112.00**

Replaced Old Famco No :

Oem Ref	Vehicle/Model	Engine
7422485068	Midlum 42B3/4-44T/V/C.- 45D./E.	
5010553652	Midlum FAB-42US-44US-45US Midlum 4x4 47XA/47XC Midlum CCF 4x4 FAB-47XF Premium FAB-22EE/HA/HB/JJ/ QQ/RR Premium PR 4x2 FAB-22AA/AB Puncher	

\* ø 44x23 mm

\* with metal gasket



Package Weight : **6,350 kg**  
Package Dimensions : **24,5x28,5x14,5 cm**



WATER PUMP

**12.6110.00**

Replaced Old Famco No :

Oem Ref	Vehicle/Model	Engine
5600409620	CS200/250/300	
5010258977	G200/210/230T1	
5001837288	JE13/15	
5000793895	M/S150/180/210/220/230T1/250	
	M/S 4x4 & Incendie	
	M140/160/200/230	
	M210 4x4	
	ME/SE/CE	
	160/180/210	
	Midliner	
	Great Britain	
	Midlum	
	FAB-42B1/2-43C1/2-43T/V	
	MS300	
	Premium PR 4x2	
	S135/150	
	MOT 040226	
	S140/160	
	TRM180/200	

5600409620

5010258977

5001837288

5000793895

M/S150/180/210/220/230T1/250

M/S 4x4 &amp; Incendie

M140/160/200/230

M210 4x4

ME/SE/CE

160/180/210

Midliner

Great Britain

Midlum

FAB-42B1/2-43C1/2-43T/V

MS300

Premium PR 4x2

S135/150

MOT 040226

S140/160

TRM180/200

\* ø 44x11 mm

\*without stopper

\*with metal gasket



Package Weight : **6,250 kg**  
 Package Dimensions : **24,5x28,5x14,5 cm**



**08.3601.00**  
 Ref : 5000667545



**09.2351.00**  
 Ref : 5010622303



**01.2603.00**  
 Ref : 5010258146



**09.5169.00**  
 (Paper Gasket)



**09.5170.00**  
 (Metal Gasket)  
 Ref : 5010258546

WATER PUMP

**12.1260.00**

Replaced Old Famco No :

Oem Ref	Vehicle/Model	Engine
7422107716		TAD851
7422951347		D13C
7423154957		D13K
7423552771		TAD570-72VE
7485020541		TAD540-42VE
7485021611		TAD550-51VE
7485021778		TAD552VE
7485022485		TAD570-71VE-B
		TAD580-83VE
		TAD870-73VE
		TAD840-43VE
		TAD850-52VE
		TAD853VE
		TAD880-84VE
		TAD840GE
		TAD880-82GE
		TAD841-43GE
		TAD851-53GE



Package Weight : **9,200 kg**  
Package Dimensions : **23x35x23 cm**



**01.2109.00**



**03.1103.00**



**03.2110.00**



**03.4103.00**



**09.5175.00**  
Ref : 21795852

VOLVO

SCANIA

MERCEDES-BENZ

MAN

DAF

RENAULT

IVECO

OTHERS

FOR IVECO



[www.famco.com.tr](http://www.famco.com.tr)

WATER PUMP

# 12.7010.00

Replaced Old Famco No : FM821001000

Oem Ref	Vehicle/Model	Engine
42530033	330 – 36 H	8210.42.011
93190287	190 – 36 TURBOTECH	8210.42.073
	220 – 36 TURBOTECH	8210.42.074
	240 – 36 TURBOTECH	8210.42.077
	260 – 36 TURBOTECH	8210.42.151
	190 – 36 TURBOSTAR	8210.42.152
	240 – 36 TURBOSTAR	8210.42.154
	260 – 36 TURBOSTAR	8210.42.155
	190 – 36 GV TURBO-TECH	8210.42.160
	240 – 36 GV TURBO-TECH	8210.42.162
		8210.42.172
		8210.42.181
		8210.42.185
		8210.42.191
		8210.42.195

\*Drive gear:19 teeth



Package Weight : **4,100 kg**  
Package Dimensions : **17,5x18,5x16 cm**



**03.6704.00**



**09.2313.00**



**09.4003.00**



**01.2701.00**

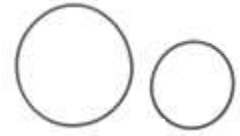

**16.7010.00**

REPAIR KIT

# 15.7010.00

Replaced Old Famco No : FM821001010

Oem Ref	Vehicle/Model	Engine
	330 – 36 H	8210.42.011
	190 – 36 TURBOTECH	8210.42.073
	220 – 36 TURBOTECH	8210.42.074
	240 – 36 TURBOTECH	8210.42.077
	260 – 36 TURBOTECH	8210.42.151
	190 – 36 TURBOSTAR	8210.42.152
	240 – 36 TURBOSTAR	8210.42.154
	260 – 36 TURBOSTAR	8210.42.155
	190 – 36 GV TURBO-TECH	8210.42.160
	240 – 36 GV TURBO-TECH	8210.42.162
		8210.42.172
		8210.42.181
		8210.42.185
		8210.42.191
		8210.42.195



WATER PUMP

**12.7020.00**

Replaced Old Famco No : FM821011000

Oem Ref	Vehicle/Model	Engine
42530032	190 – 30 N	
93190286	190 – 30 N – NT	
503475055	190 – 36 TURBOSTAR	
	190 – 36 TURBOTECH	
	260 – 36 TURBOTECH	
	330 – 30 N	
	330 – 30 N – NW	
	330 – 36 H	

\*Drive gear:24 teeth



Package Weight : **3,850 kg**  
 Package Dimensions : **17,5x18,5x16 cm**

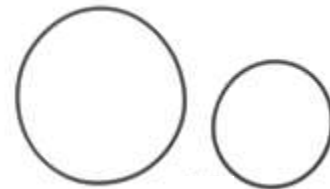

**03.6703.00**



**09.2313.00**



**09.4003.00**



**01.2701.00**

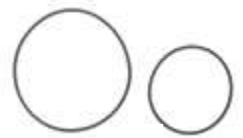

**16.7010.00**

REPAIR KIT

**15.7010.00**

Replaced Old Famco No : FM821001010

Oem Ref	Vehicle/Model	Engine
	330 – 36 H	8210.42.011
	190 – 36 TURBOTECH	8210.42.073
	220 – 36 TURBOTECH	8210.42.074
	240 – 36 TURBOTECH	8210.42.077
	260 – 36 TURBOTECH	8210.42.151
	190 – 36 TURBOSTAR	8210.42.152
	240 – 36 TURBOSTAR	8210.42.154
	260 – 36 TURBOSTAR	8210.42.155
	190 – 36 GV TURBO-TECH	8210.42.155
	240 – 36 GV TURBO-TECH	8210.42.160
		8210.42.162
		8210.42.172
		8210.42.181
		8210.42.185
		8210.42.191
		8210.42.195



WATER PUMP

**12.7050.00**

Replaced Old Famco No : FM846001000

Oem Ref	Vehicle/Model	Engine
500350798	Eurotech	8460.21
93190284	180 E30 – E34	6 cyl.
	190 E30 – E34	9495 cm <sup>3</sup>
	190 E38 – 240 E38	8460.21-8460.41
	400 E34 – 400 E38	
	440 E34	
	Eurotrakker	
	190 E34 H	
	380 E34 H	
	Eurostar	
	190 E38 – 242 E38	
	440 E38	
	HD7 44.34	
	HD7 64.34	
	HD7 66.34	
	Bus Euroclass	
	370, 380, 391, 590	
	Top Class Orlandi	

\*Drive gear:23 teeth



Package Weight : **4,200 kg**  
Package Dimensions : **17,5x18,5x16 cm**

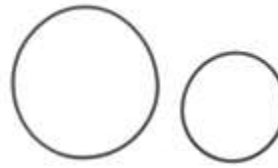

**03.6702.00**



**09.2313.00**



**09.4003.00**



**01.2701.00**

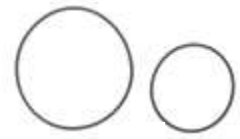

**16.7010.00**

REPAIR KIT

**15.7010.00**

Replaced Old Famco No : FM821001010

Oem Ref	Vehicle/Model	Engine
	330 – 36 H	8210.42.011
	190 – 36 TURBOTECH	8210.42.073
	220 – 36 TURBOTECH	8210.42.074
	240 – 36 TURBOTECH	8210.42.077
	260 – 36 TURBOTECH	8210.42.077
	190 – 36 TURBOSTAR	8210.42.151
	240 – 36 TURBOSTAR	8210.42.152
	260 – 36 TURBOSTAR	8210.42.152
	190 – 36 GV TURBO-TECH	8210.42.154
	240 – 36 GV TURBO-TECH	8210.42.155
		8210.42.160
		8210.42.162
		8210.42.172
		8210.42.181
		8210.42.185
		8210.42.191
		8210.42.195



WATER PUMP

**12.7030.00**

Replaced Old Famco No : FM821021000

Oem Ref	Vehicle/Model	Engine
500350785	Eurotech	8210.42
99445447	Eurotrakker	8210.42
98479675	Eurostar	
93190285	up to / bis: 1995 HD7	

\*Drive gear: 19 teeth

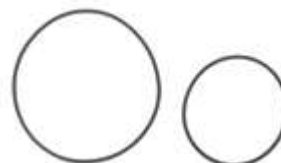
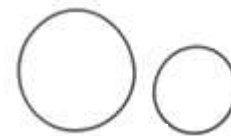

Package Weight : **4,200 kg**  
 Package Dimensions : **17,5x18,5x16 cm**

**03.6704.00****09.2313.00****09.4003.00****01.2701.00****16.7010.00**

REPAIR KIT

**15.7010.00**

Replaced Old Famco No : FM821001010

Oem Ref	Vehicle/Model	Engine
330 - 36 H		8210.42.011
190 - 36 TURBOTECH		8210.42.073
220 - 36 TURBOTECH		8210.42.074
240 - 36 TURBOTECH		8210.42.077
260 - 36 TURBOTECH		8210.42.151
190 - 36 TURBOSTAR		8210.42.152
240 - 36 TURBOSTAR		8210.42.154
260 - 36 TURBOSTAR		8210.42.155
190 - 36 GV TURBO-TECH		8210.42.155
240 - 36 GV TURBO-TECH		8210.42.160
		8210.42.162
		8210.42.172
		8210.42.181
		8210.42.185
		8210.42.191
		8210.42.195





WATER PUMP

**12.7040.00**

Replaced Old Famco No : FM836001000

Oem Ref	Vehicle/Model	Engine
42535615 42532082	Eurocargo 120 E 27 150 E 27 170 E 27 R 320 E 27	8360.46
	Eurotech 180 E 27 190 E 27 190 E 27 K	
	Cityclass 491.10.22 – 491.12.22 491.10.27 – 491.12.27 591.10.22 – 591.12.22 591.10.27 – 591.12.27	
*Drive gear:21 teeth	370 S – E 9.27 490.18.29 490 E.12.22 590 E.12.22	



Package Weight : **3,500 kg**  
Package Dimensions : **17,5x18,5x16 cm**

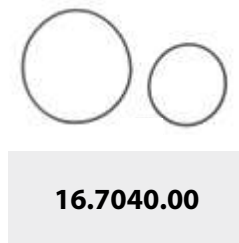

REPAIR KIT

**15.7040.00**

Replaced Old Famco No : FM836001010

Oem Ref	Vehicle/Model	Engine
	Eurocargo 120 E 27 150 E 27 170 E 27 R 320 E 27	8360.46
	Eurotech 180 E 27 190 E 27 190 E 27 K	
	Cityclass 491.10.22 – 491.12.22 491.10.27 – 491.12.27 591.10.22 – 591.12.22 591.10.27 – 591.12.27	



WATER PUMP

**12.7060.00**

Replaced Old Famco No : FM846011000

Oem Ref	Vehicle/Model	Engine
500356553	Astra HD9	F3AE0681B
5801931139	EuroStar Cursor	F3AE0681D
5801807827	EuroTech Cursor	F3AE0681E
99468634	EuroTrakker Cursor	F3AE3681A
	PowerStar E3	F3AE3681B
	PowerStar E4	F3AE3681D
	Stralis	F3AE3681Y
	Stralis MY 2007	F3AE681B
	Stralis MY 2013	F3AE681D
	Stralis E3	F3B3681A
	Stralis E4	F3B3681B
	Stralis E5	F3BE0681A
	Trakker	F3BE0681B
	Trakker MY 2007	F3BE0681C
	Trakker MY 2013	F3BE0681E
	Trakker DV	F3BE0681F
	Trakker E4	F3BE0681G
	Trakker EE	F3BE0681V
	Belgium Army	F3BE3681A

\*Pulley with: 12 grooves



Package Weight : **4,800 kg**  
 Package Dimensions : **19x20x18 cm**



**02.1703.00**  
 Ref : 928367



**09.2333.00**



**09.4003.00**



**06.1701.00**  
 Ref : 926388

REPAIR KIT

**15.7060.00**

Replaced Old Famco No : FM846011010

Oem Ref	Vehicle/Model	Engine
	Eurotar	F3BE0681
	LD 440	
	Eurotrakker	
	MP 190 E	
	MP 260 E	
	MP 340 E	
	MP 410 E	
	Stralis	
	AS 260 S 48	
	AS 260 S 54	
	AS 440 S 48	
	AS 440 S 54	
	Trakker	
	AD 190 T 38W	
	AD 190 T 44W	
	AD 260 T 38	



WATER PUMP

**12.7090.00**

Replaced Old Famco No : FM846041000

Oem Ref	Vehicle/Model	Engine
504093706	Arway N 15M	F3AE0681C
5801807832	Domino HD MY 2009	F3AE0681D B904/905
5801931141	Domino HDH MY 2009	F3AE0682 F3AE3681
	EuroRider 38	F3AE3681A
	EuroRider 38 E4	F3AE3681C
	EuroRider 38 MY 2009	F3AE3682
	EuroRider 43	F3AE3682A
	EuroRider 43 MY 2009	F3AE3682C
	EuroRider 45 E4	
	EuroRider 45 MY 2009	
	Evadys HD EURO4	
	Magelys HD	
	Magelys HDH	
	Magelys PRO	
	New Domino HD	
	New Domino HDH	

\*Pulley with: 4 grooves



Package Weight : **4,900 kg**  
Package Dimensions : **17,5x18,5x16 cm**



**02.1704.00**



**09.2333.00**



**09.4003.00**



**06.1701.00**  
Ref : 926388

REPAIR KIT

**15.7060.00**

Replaced Old Famco No : FM846011010

Oem Ref	Vehicle/Model	Engine
	Eurotar LD 440	F3BE0681
	Eurotrakker MP 190 E	
	MP 260 E	
	MP 340 E	
	MP 410 E	
	Stralis AS 260 S 48	
	AS 260 S 54	
	AS 440 S 48	
	AS 440 S 54	
	Trakker AD 190 T 38W	
	AD 190 T 44W	
	AD 260 T 38	



WATER PUMP

**12.7070.00**

Replaced Old Famco No : FM846021000

Oem Ref	Vehicle/Model	Engine
5801931331	Cabinato	F2BE0641A
5001859590	EuroMover	F2BE0641D
504201935	EuroTech Cursor	F2BE0641G
99483937	EuroTrakker Cursor	F2BE0641K
99460305	Stralis	F2BE0681A
	Stralis MY 2007	F2BE0681B
	Stralis MY 2013	F2BE0681C
	Stralis E4	F2BE0681D
	Stralis E6	F2BE0681E
	Trakker	F2BE0681F
	Trakker MY 2007	F2BE3681
	Trakker MY 2013	F2BE3681A
	Trakker E4	F2BE3681B
	Trakker E6	F2BE3681C
		F2BEE681A
		F2BFA601D
		F2BFA601G
		F2BFA601K

\*Pulley with: 10 grooves



Package Weight : **3,850 kg**  
Package Dimensions : **17,5x18,5x16 cm**



**02.1701.00**  
Ref : 927056



**09.2338.00**



**09.4003.00**



**06.1702.00**  
Ref : 926413

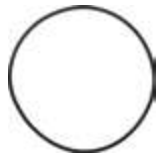

**09.1504.00**  
Ref : 17291781

REPAIR KIT

**15.7070.00**

Replaced Old Famco No : FM846021010

Oem Ref	Vehicle/Model	Engine
	Cabinato	F2BE0641A
	EuroMover	F2BE0641D
	EuroTech Cursor	F2BE0641G
	EuroTrakker Cursor	F2BE0641K
	Stralis	F2BE0681A
	Stralis MY 2007	F2BE0681B
	Stralis MY 2013	F2BE0681C
	Stralis E4	F2BE0681D
	Stralis E6	F2BE0681E
	Trakker	F2BE0681F
	Trakker MY 2007	F2BE3681
	Trakker MY 2013	F2BE3681A
	Trakker E4	F2BE3681B
	Trakker E6	F2BE3681C
		F2BEE681A
		F2BFA601D
		F2BFA601G



WATER PUMP

**12.7100.00**

Replaced Old Famco No : FM846051000

Oem Ref	Vehicle/Model	Engine
5801702443	203E.9.27	F2BE0682A
5801931312	397.18.31 China	F2BE0682B
504029280	399.35 MY WAY	F2BE0682C
	Arway N E3/E4	F2BE0682D
	Citelis 10-DS	F2BE0682F
	Citelis 10M-CNG	
	Citelis 12M	
	Citelis 12M-CNG	
	Citelis 18M-CNG	
	Citelis 18M-DS	
	Citelis CH 12M	
	Citelis PKD-12M	
	Citelis PKD-18M	
	CityClass 25	
	CityClass 29	
	CityClass 35	
	CityClass 491.27...	
	CityClass 591.27	

\*Pulley with: 4 grooves



Package Weight : **3,700 kg**  
Package Dimensions : **19x20x18 cm**



**02.1702.00**



**09.2338.00**



**09.4003.00**



**06.1702.00**

REPAIR KIT

**15.7070.00**

Replaced Old Famco No : FM846021010

Oem Ref	Vehicle/Model	Engine
	Cabinato	F2BE0641A
	EuroMover	F2BE0641D
	EuroTech Cursor	F2BE0641G
	EuroTrakker Cursor	F2BE0641K
	Stralis	F2BE0681A
	Stralis MY 2007	F2BE0681B
	Stralis MY 2013	F2BE0681C
	Stralis E4	F2BE0681D
	Stralis E6	F2BE0681E
	Trakker	F2BE0681F
	Trakker MY 2007	F2BE3681
	Trakker MY 2013	F2BE3681A
	Trakker E4	F2BE3681B
	Trakker E6	F2BE3681C
		F2BEE681A
		F2BFA601D
		F2BFA601G



WATER PUMP

**12.6011.00**

Replaced Old Famco No : FM032001000

Oem Ref	Vehicle/Model	Engine
503136205		



Package Weight : **4,200 kg**  
 Package Dimensions : **17,5x18,5x16 cm**

**03.6601.00****09.2337.00****09.4003.00****01.2601.00****16.6011.00**

REPAIR KIT

**15.6011.00**

Replaced Old Famco No : FM032001010

Oem Ref	Vehicle/Model	Engine
	MAXTER	MIDR 062045/141
	G 340 TI 6x6	MIDR 062045E
	G 340 TI TR 18 T	
	PREMIUM TR 4x2	
	PREMIUM 6x2 & 6x2/4	
	MAXTER 4x2 - 4x4	
	PREMIUM PR 4x2	
	KERAX	
	PREMIUM 260 SP	
	PREMIUM TR 4x2	
	PREMIUM AB 22 E / H	
	// J / Q / R	
	PREMIUM PR 4x2 (FAB 22A)	
	KERAX (FAB 33A)	



WATER PUMP

**12.7080.00**

Replaced Old Famco No : FM846031000

Oem Ref	Vehicle/Model	Engine
504062854	Citelis	F4AE0481A
503622660	Crealis	F4AE0481B
4891252	CrossWay	F4AE0481C
	CrossWay/Recreo	F4AE0481D
	CrossWay E6	F4AE0681A
	EuroFire	F4AE0681B
	EuroFire Restyling	F4AE0681D
	EuroFire Tector	F4AE0681E
	EuroPolis MY 2010	F4AE3481A
	EuroRider	F4AE3481B
	EuroRider MY 2012	F4AE3481C
	MidiRider	F4AE3481D
	MidiRider E4	F4AE3681
	MidiRider MY 2009	F4AE36813
	ProWay E3/E4	F4AE3681A
	Proxys E3	F4AE3681B
	Tector	F4AE3681C
	Tector Restyling	F4AE3681D
	UrbanWay E6	F4AE3681E
		F4AEE681A
		F4AEE681B
		F4AEE681E
		F4AEE681G



Package Weight : **2,600 kg**  
Package Dimensions : **17,5x18,5x16 cm**



**02.1501.00**  
Ref : 451091



**02.1504.00**  
Ref : 451109



**09.2334.00**



**09.4002.00**



**06.1502.00**

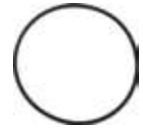

**09.1536.00**  
Ref : 504062856

REPAIR KIT

**15.7080.00**

Replaced Old Famco No : FM846031010

Oem Ref	Vehicle/Model	Engine
	Citelis	F4AE0481A
	Crealis	F4AE0481B
	CrossWay	F4AE0481C
	CrossWay/Recreo	F4AE0481D
	CrossWay E6	F4AE0681A
	EuroFire	F4AE0681B
	EuroFire Restyling	F4AE0681D
	EuroFire Tector	F4AE0681E
	EuroPolis MY 2010	F4AE3481A
	EuroRider	F4AE3481B
	EuroRider MY 2012	F4AE3481C
	MidiRider	F4AE3481D
	MidiRider E4	F4AE3681
	MidiRider MY 2009	F4AE36813
	ProWay E3/E4	F4AE3681A
	Proxys E3	F4AE3681B
	Tector	F4AE3681C



WATER PUMP

**12.7081.00**

Replaced Old Famco No :

Oem Ref	Vehicle/Model	Engine
5801616096	Eurocargo	



Package Weight : **3,000 kg**  
 Package Dimensions : **17,5x18,5x16 cm**

**08.3601.00****09.2351.00**

**01.2603.00**  
 Ref : 426641



**09.5169.00**  
 (Paper Gasket)



**09.5170.00**  
 (Metal Gasket)  
 Ref : 5010258546

WATER PUMP

**12.6111.00**

Replaced Old Famco No :

Oem Ref	Vehicle/Model	Engine
503136201		

\*ø 44x11 mm

\*with stopper

\*with metal gasket



Package Weight : **6,250 kg**  
 Package Dimensions : **24,5x28,5x14,5 cm**





WATER PUMP

# 12.7110.00

Replaced Old Famco No :

Oem Ref	Vehicle/Model	Engine
5801938458	AD/AT/AS Stralis	
5801897787	AD/AT Trakker	
5801795031	Astra HD 9	

\*Pulley diameter Ø 110 mm



Package Weight : **6,300 kg**  
Package Dimensions : **19x20x18 cm**



**02.1705.00**  
Ø 110 mm  
Ref : 17010520



**02.1707.00**  
Ø 120 mm  
Ref : 21008573



**06.1703.00**  
Ref : 927067

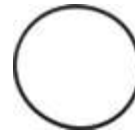

**09.1594.00**  
Ref : 17292681

WATER PUMP

# 12.7112.00

Replaced Old Famco No :

Oem Ref	Vehicle/Model	Engine
5801870209		
5801938457		

\*Pulley diameter Ø 120 mm



Package Weight : **6,500 kg**  
Package Dimensions : **19x20x18 cm**



WATER PUMP

**12.7111.00**

Replaced Old Famco No :

Oem Ref	Vehicle/Model	Engine
5801938449		
5801897755		
5801795263		
5801525568		

5801938449		
5801897755		
5801795263		
5801525568		

\*Pulley diameter Ø 130 mm



Package Weight : **6,700 kg**  
 Package Dimensions : **19x20x18 cm**



**02.1706.00**  
 Ø 130 mm  
 Ref : 19005112



**06.1703.00**  
 Ref : 927067

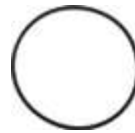

**09.1594.00**  
 Ref : 17292681

FOR **OTHERS**



[www.famco.com.tr](http://www.famco.com.tr)



VOLVO

SCANIA

MERCEDES-BENZ

MAN

DAF

RENAULT

IVECO

OTHERS

WATER PUMP

## 12.8010.00

### FORD

Oem Ref	Vehicle/Model	Engine
2C468B546JA		T192513

\*Pulley diameter Ø 162 mm



Package Weight : **7,500 kg**  
Package Dimensions : **28x40x18 cm**



**02.1801.00**  
Ref : 2C468509BA  
Ø 162 mm



**09.2353.00**  
Ref : 2C468530BA



**09.4003.00**  
Ref : 2C468A559AA



**01.2801.00**  
Ref : 2C468512AA  
Ø110mm



**09.5165.00**  
(Paper Gasket)  
Ref : 9C468507AA



**09.5166.00**  
(Metal Gasket)  
Ref : 9C468507BA

WATER PUMP

## 12.8021.00

### FORD

Oem Ref	Vehicle/Model	Engine
EC468B546BC	CARGO 2003 (H298)	T330641
EC468B546BB		T194133
6C468B546JA		

\*Pulley diameter Ø 162 mm

\*with metal gasket



Package Weight : **6,200 kg**  
Package Dimensions : **24x40x16 cm**



WATER PUMP

**12.8020.00**

**FORD**

Oem Ref	Vehicle/Model	Engine
EC468B546AB	CARGO 2003 (H298)	T222202
6C468B546KA		T217255
EC468B546AA		

\*Pulley diameter Ø 150 mm

\*with metal gasket



Package Weight : **6,000 kg**  
Package Dimensions : **24x40x16 cm**



**02.1802.00**

Ref : 6C468509AA  
Ø 150 mm



**02.1804.00**

Ref : 8C468509AA  
Ø 150 mm



**09.5166.00**

Ref : 9C468507BA  
(Metal Gasket)



**01.2801.00**

Ref : 2C468512AA  
Ø 117mm

WATER PUMP

**12.8022.00**

**FORD**

Oem Ref	Vehicle/Model	Engine
8C468B546CB		T222581

\*Pulley diameter Ø 150 mm



Package Weight : **6,400 kg**  
Package Dimensions : **24x40x16 cm**



WATER PUMP

12.8030.00

**FORD**

Oem Ref	Vehicle/Model	Engine
GC468501AF	CARGO 2007 (H476)	T230367



Package Weight : **4,300 kg**  
 Package Dimensions : **22,5x24,5x16 cm**



**02.1803.00**  
 Ref: GC468509CA  
 Ø 160 mm

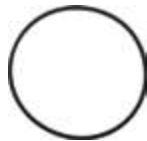

**09.1576.00**



**06.1801.00**  
 Ref: GC468512BB

WATER PUMP

12.8050.51

**FORD**

Oem Ref	Vehicle/Model	Engine
Fit for the below Oem Ref:	Ford Trucks H566 F-Max	T354897 T328495 T281625 T220247
GC468501DH GC468501DG GC468501DF GC468501DD		



Package Weight : **6,100 kg**  
 Package Dimensions : **21x25x22 cm**

WATER PUMP

**12.8040.00**

**FORD**

Oem Ref	Vehicle/Model	Engine
GC468B546FB		T245552



Package Weight : **5,400 kg**  
Package Dimensions : **28x40x18 cm**



**02.1806.00**  
Ref : GC468509BB



**02.1805.00**  
Ref : GC468509BA



**06.1802.00**  
Ref : GC468512CA



**09.5179.00**  
Ref : GC468507BA

WATER PUMP

**12.8041.00**

**FORD**

Oem Ref	Vehicle/Model	Engine
GC468B546FE		T398799



Package Weight : **6,100 kg**  
Package Dimensions : **28x40x18 cm**



WATER PUMP

12.9010.00

**DAEWOO**

Oem Ref	Vehicle/Model	Engine
40092100090		
40092100021		
40092100021A		
40092100021B		

40092100090  
40092100021  
40092100021A  
40092100021B



Package Weight : **22,200 kg**  
Package Dimensions : **50x28x23 cm**



**01.3901.00**



**01.2901.00**  
Ref : 65065066001  
400902-00067A  
51065066011



**08.1110.00**



**03.1901.00**



**09.5167.00**  
(Paper Gasket)

WATER PUMP

12.9011.00

**DAEWOO**

Oem Ref	Vehicle/Model	Engine
42192100016		

42192100016



Package Weight : **21,000 kg**  
Package Dimensions : **50x28x23 cm**





[www.famco.com.tr](http://www.famco.com.tr)



*Save water  
For the future...*

**FAMCO**<sup>®</sup>  
GENUINE

VOLVO

SCANIA

MERCEDES-BENZ

MAN

DAF

RENAULT

IVECO

OTHERS

*Special production solutions  
for special customers.*



VOLVO

SCANIA

MERCEDES-BENZ

MAN

DAF

RENAULT

IVECO

OTHERS

[www.famco.com.tr](http://www.famco.com.tr)

EXPORT TO  
MORE THAN  
**45**  
COUNTRIES



**FAMCO**<sup>®</sup>  
GENUINE

VOLVO

SCANIA

MERCEDES-BENZ

MAN

DAF

RENAULT

IVECO

OTHERS

VOLVO

SCANIA

MERCEDES-BENZ

MAN

DAF

RENAULT

IVECO

OTHERS



# CHOICE OF LEADERS



**FAMCO**  
GENUINE

FA-ME OTOMOTİV DÖKÜM MAKİNE SAN. ve TİC. LTD. ŞTİ.

Büyükkayacık Osb Mah. 5. Org. Sanayi Bölgesi 511 Nolu Sk.  
No:13 Selçuklu / KONYA

Phone: +90 332 345 22 55 (pbx) - Fax: +90 332 345 00 15  
www.famco.com.tr - sales@fameotomotiv.com



TUV NORD