

CATALOG

WATER PUMPS
OIL PUMPS
FUEL FEED PUMPS
REPAIR KITS
HOUSINGS
PARTS



FAMCO[®]
GENUINE

2025¹
PRODUCT
CATALOG

www.famco.com.tr

VOLVO

SCANIA

MERCEDES-BENZ

MAN

DAF

RENAULT

IVECO

OTHERS

ABOUT US

Founded in 1967 Fa-Me Automotive, at the beginning of the 2000s started production of water pumps for heavy trucks and commercial vehicles. FAMCO brand, which is being exported to more than 45 countries became one of the preferred brands, because of aiming at improving quality and customer satisfaction.

By following the new technologies, producing with renewed technical equipment and in accordance with ISO9001:2015 certificate, the company is continuing to expand the range of water pumps for VOLVO, DAF, SCANIA, MAN, MERCEDES, RENAULT, IVECO and OTHERS heavy trucks.

*From part to
the Whole...*

OUR MISSION

Our mission is to protect, expand and maintain the superior service concept and quality, and share it with the world as the best in its sector.

OUR VISION

Our vision is to meet the customers expectations and demands quickly and completely, and ensure the continuity of customers satisfaction.

FAMCO IS;

- High technologies;
- Continuous improvement of product and service quality;
- Two-step leakage testing system;
- Quality tested by hundreds of thousands of vehicles all over the world.





PRODUCTION

For today the company is producing more than 150 kinds of water pumps for heavy trucks like IVECO, SCANIA, VOLVO, MAN, MERCEDES, RENAULT, DAF and OTHERS. The product development department is working on expanding the range and satisfying all the needs of our customers.

QUALITY

All products comply with ISO9001:2015 certificate and are covered by an international warranty of 1 year or 100000 km.

Almost all components, except bearing, mechanical seal and raw materials are producing directly at the factory. 92% of suppliers belong to an A-group. The quality control department constantly monitors changes on the market and chooses the most reliable suppliers from a huge variety of offers.

EXPORT

FAMCO is exporting water pumps to more than 45 countries.



Germany
Spain
Estonia
Italy
Greece
Portugal
Poland
The UK
The Netherlands
Belgium

Ireland
Israil
Kyrgyzstan
Russia
South Korea
Colombia
Peru
Chile
Syria
Libya
UAE

Iran
Iraq
Egypt
Yemen
Jordan
Lebanon
Tunisia
South Africa
Ethiopia
Tanzania
Sri Lanka
U.S.A....

VOLVO

SCANIA

MERCEDES-BENZ

MAN

DAF

RENAULT

IVECO

OTHERS

VOLVO

SCANIA

MERCEDES-BENZ

MAN

DAF

RENAULT

IVECO

OTHERS



*Quality
is important*

FAMCO[®]



www.famco.com.tr

VOLVO

SCANIA

MERCEDES-BENZ

MAN

DAF

RENAULT

IVECO

OTHERS

FOR SCANIA



www.famco.com.tr



WATER PUMP

12.2030.00

Replaced Old Famco No : FM124G01000

Oem Ref	Vehicle/Model	Engine
1896752	114G	D 9 / 11 / 12
1508533	124 C/G/L	DC 9 19 / 20 / 21
1353072	P-, G-, R-, T LKW	D 11 / 12
	4 LKW, 4 BUS	DSC 11 74 / 75 / 79
	4 LKW	D 12 A
(570962)		D 12 M
(570955)		DC 12 MOXY
(570951)		DI 12 49 A

*impeller: ø 105 mm
blade: 17 mm



Package Weight : **3,600 kg**
Package Dimensions : **22,5x24,5x16 cm**

HOUSING

11.2030.00

Replaced Old Famco No : FM124G02000

Oem Ref	Vehicle/Model	Engine
1450153	4 Truck	D9
1376495	P-, G-, R-, T	D11
	Truck	D12
	4 Bus	DC9
	P96 Industrial /	DC12A
	Marine	Moxy



Package Weight : **1,850 kg**
Package Dimensions : **25,5x28x7,5 cm**

REPAIR KIT

15.2030.00

Replaced Old Famco No : FM124G01010

Oem Ref	Vehicle/Model	Engine
551355	114G	D 9 / 11 / 12
552127	124 C/G/L	DC 9 19 / 20 / 21
552107	P-, G-, R-, T LKW	D 11 / 12
	4 LKW, 4 BUS	DSC 11 74 / 75 / 79
	4 LKW	D 12 A
		D 12 M
		DC 12 MOXY
		DI 12 49 A



01.2201.00
Ref : 1460083

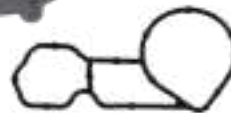

WATER PUMP

12.2060.00

Replaced Old Famco No : FM144G01000

Oem Ref	Vehicle/Model	Engine
1508532	144G	DSC 14
1508534	144L	D14
1365841	4LKW	
(570966)		
(570956)		
(570952)		



Package Weight : **3,550 kg**
 Package Dimensions : **22,5x24,5x16 cm**



02.1201.00
 Ref : 1781673
 1413135



09.2319.00
 Ref : 1382541
 750153



09.1597.00
 Ref : 1403883



01.2205.00

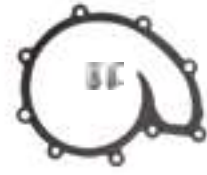

16.2060.00



09.5116.00

REPAIR KIT

15.2060.00

Replaced Old Famco No : FM144G01010

Oem Ref	Vehicle/Model	Engine
551369	144G	DSC 14
552129	144L	D14
552126	4LKW	
552109		
552106		



WATER PUMP

12.2010.00

Replaced Old Famco No : FM124R01000

Oem Ref	Vehicle/Model	Engine
1789522	124R	D 9 PDE
1546188	144R	D 11
1533783	P-, G-, R-, T 4 LKW, 4 Bus	D 12 DC 9 19 / 20 / 21 D 11 / 12
(570965)	F-, K-, N Bus	DC 12 MOXY
(570964)		DC 12 57 A
(570959)		SG 9 A 280 DC 9 A EMS

*impeller: ø 112 mm
blade: 21 mm



Package Weight : **3,650 kg**
Package Dimensions : **22,5x24,5x16 cm**



02.1204.00
Ref : 1779993
1529076



09.2322.00
Ref : 1528923



01.2204.00
Ref : 1534248

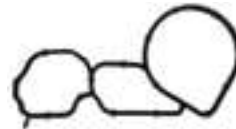

09.1539.00
Ref : 1879484
1549027



09.5118.00
Ref : 1541633

REPAIR KIT

15.2010.00

Replaced Old Famco No : FM124R01010

Oem Ref	Vehicle/Model	Engine
GENERAL OVERHAUL KIT	124R 144R P-, G-, R-, T 4 LKW, 4 Bus F-, K-, N Bus	D 9 PDE D 11 D 12 DC 9 19 / 20 / 21 D 11 / 12 DC 12 MOXY DC 12 57 A SG 9 A 280 DC 9 A EMS

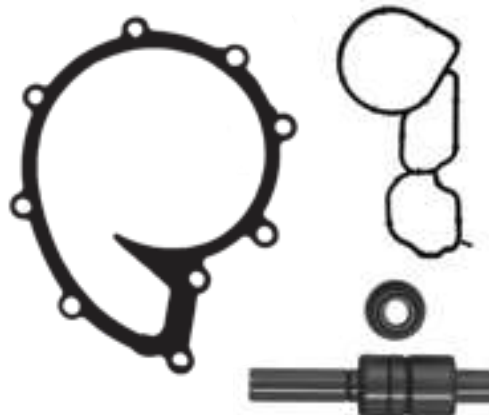

WATER PUMP

10.2010.00

Replaced Old Famco No : FM124R03000

Oem Ref	Vehicle/Model	Engine
1787120	124R	D 9 PDE
570965	144R	D 11
	P-, G-, R-, T	D 12
	4 LKW, 4 Bus	DC 9 19 / 20 / 21
	F-, K-, N Bus	D 11 / 12
		DC 12 MOXY
		DC 12 57 A
		SG 9 A 280
		DC 9 A EMS



Package Weight : **5,150 kg**
 Package Dimensions : **24,5x28,5x14,5 cm**

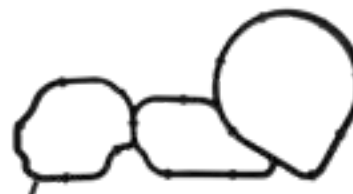

HOUSING

11.2010.00

Replaced Old Famco No : FM124R02000

Oem Ref	Vehicle/Model	Engine
1787121	124R	D 9 PDE
1528348	144R	D 11
	P-, G-, R-, T	D 12
	4 LKW, 4 Bus	DC 9 19 / 20 / 21
	F-, K-, N Bus	D 11 / 12
		DC 12 MOXY
		DC 12 57 A
		SG 9 A 280
		DC 9 A EMS



Package Weight : **1,70 kg**
 Package Dimensions : **25,5x28x7,5 cm**

WATER PUMP

12.2071.00

Replaced Old Famco No : FM480R11000

Oem Ref	Vehicle/Model	Engine
2006397	P-, G-, R-, T	D 13
2224112	F-, K-, N	D 9 XPI
2224147	E 2011	DC 09 / 13A
576662		DI 13M

*impeller: ø 120 mm



Package Weight : **4,750 kg**
Package Dimensions : **24,5x28,5x14,5 cm**



02.1202.00
Ref : 2006207



09.2335.00



09.4002.00



06.1201.00
Ref : 2006209



09.1541.00
Ref : 1886594
1782197

REPAIR KIT

15.2071.00

Replaced Old Famco No : FM480R11010

Oem Ref	Vehicle/Model	Engine
	P-, G-, R-, T	D 13
	F-, K-, N	D 9 XPI
	E 2011	DC 09 / 13A
		DI 13M



WATER PUMP

12.2070.00

Replaced Old Famco No : FM480R01000

Oem Ref	Vehicle/Model	Engine
1884327	P-, G-, R-, T	D 13
2224045	F-, K-, N	D 9 XPI
1789555	E 2011	DC 09 / 13A
1778923		DI 13M
1939481		
2034084		
(576663)		
(570193)		
(570194)		

*impeller: ø 113 mm



Package Weight : **5,200 kg**
 Package Dimensions : **24,5x28,5x14,5 cm**

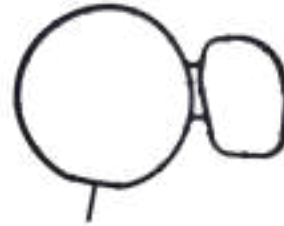

02.1203.00
Ref : 1793651



09.2322.00
Ref : 1528923



09.4003.00
Ref : 1435069



01.2206.00
Ref : 1884336



09.5120.00
Ref : 1778922

REPAIR KIT

15.2070.00

Replaced Old Famco No : FM480R01010

Oem Ref	Vehicle/Model	Engine
	P-, G-, R-, T	D 13
	F-, K-, N	D 9 XPI
	E 2011	DC 09 / 13A
		DI 13M

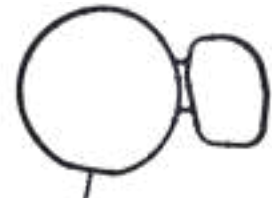

WATER PUMP

10.2080.00

Replaced Old Famco No :

Oem Ref	Vehicle/Model	Engine
2363452	L-/P-/G-/R-/S-Series	DC 16 XPI
2142744	P-/G-/R-/T-Series	DC 16
2113389		
1945069		
571244		
571149		



Package Weight : **6,800 kg**
Package Dimensions : **28x40x18 cm**



09.1599.00
Ref : 1886664



09.1598.00
Ref : 1886663



16.2080.00



02.1205.00
Ref : 2006202



06.1202.00
Ref : 2363382

HOUSING

11.2080.00

Replaced Old Famco No :

Oem Ref	Vehicle/Model	Engine
2212472	L-/P-/G-/R-/S-Series	DC 16 XPI
	P-/G-/R-/T-Series	DC 16



Package Weight : **2,250 kg**
Package Dimensions : **26x45x7,5 cm**



WATER PUMP

12.2020.00

Replaced Old Famco No : FM620R01000

Oem Ref	Vehicle/Model	Engine
1549482	P-, G-, R-, T	D 16 PDE
1546491	P 96 4 LKW	D 16M D 16A D 16
(570958)		
(570954)		



Package Weight : **3,800 kg**
 Package Dimensions : **22x35,5x14 cm**



02.1204.00
 Ref : 1779993
 1529076

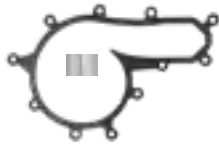

16.2022.00
 Ref : 1498650



09.5121.00
 Ref : 1427261



01.2204.00
 Ref : 1534248

REPAIR KIT

15.2020.00

Replaced Old Famco No : FM620R01010

Oem Ref	Vehicle/Model	Engine
	P-, G-, R-, T	D 16 PDE
	P 96	D 16M
	4 LKW	D 16A D 16



WATER PUMP

10.2020.00

Replaced Old Famco No : FM620R03000

Oem Ref	Vehicle/Model	Engine
1793989	P-, G-, R-, T	D 16 PDE
1549481	P 96	D 16M
1510404	4 LKW	D 16A
1433792		D 16
(570881)		
(570958)		
(570954)		



Package Weight : **6,350 kg**
Package Dimensions : **28x49,5x15,5 cm**

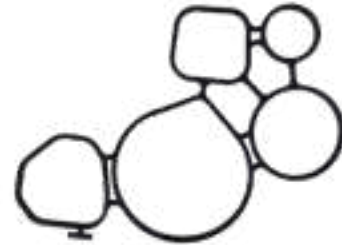
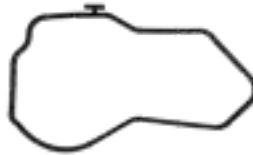

09.1542.00
Ref : 1464464



09.1552.00
Ref : 1457411



16.2020.00

HOUSING

11.2020.00

Replaced Old Famco No : FM620R02000

Oem Ref	Vehicle/Model	Engine
1793990	P-, G-, R-, T	D 16
1429397	P 96	D16 A
	4 LKW	D 16 PDE
		D 16 M



Package Weight : **2,750 kg**
Package Dimensions : **56x45x7 cm**



WATER PUMP

12.2040.00

Replaced Old Famco No : FM094001000

Oem Ref	Vehicle/Model	Engine
1510490	4 LKW	D 9
1486098	4 BUS	D 9 A
1380897	4 Industrie / Schiff- fahrt	D 9 M
		DI9 53
		DI9 56
(570961)		DC9 51
(570957)		K 94
(570953)		L 94
(571157)		N 94
		SG 9 A 280
		SGL 12 A



Package Weight : **2,250 kg**
 Package Dimensions : **17,5x18,5x16 cm**



03.1201.00
 Ref : 1486102



09.2319.00
 Ref : 1382541



09.4003.00
 Ref : 1435069



01.2207.00
 Ref : 1380902



09.5122.00
 Ref : 1384468

REPAIR KIT

15.2040.00

Replaced Old Famco No : FM094001010

Oem Ref	Vehicle/Model	Engine
550269	4 LKW	D 9
	4 BUS	D 9 A
	4 Industrie / Schiff- fahrt	D 9 M
		DI9 53
		DI9 56
		DC9 51
		K 94
		L 94
		N 94
		SG 9 A 280
		SGL 12 A

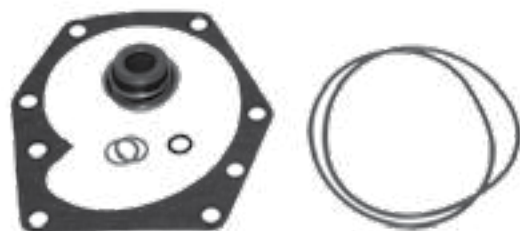

WATER PUMP

12.2011.00

Replaced Old Famco No : FM011101000

Oem Ref	Vehicle/Model	Engine
259065 (571055)	3 BUS	N113 D 11 DS11



Package Weight : **8,050 kg**
Package Dimensions : **21x25x21 cm**



03.2201.00
Ref : 228834



01.2202.00
Ref : 372310



09.5114.00
Ref : 231795



09.5119.00



16.2011.00

REPAIR KIT

15.2011.00

Replaced Old Famco No : FM011001010

Oem Ref	Vehicle/Model	Engine
550044	3 BUS	N113 D 11 DS11

15.2022.00

Replaced Old Famco No : FM011101010

Oem Ref	Vehicle/Model	Engine
550142	111 3 BUS	N113 D 11 DS11



WATER PUMP

12.2021.00

Replaced Old Famco No : FM011201000

Oem Ref	Vehicle/Model	Engine
1314406	3 BUS	CP / CR / CT 113
292761	3 TRUCK	D 11 A
(575100)		D 11 M
(571059)		F 113
		K 113
		L 113



Package Weight : **8,200 kg**
 Package Dimensions : **21x26x27 cm**



03.2202.00
 Ref : 278338



16.2021.00



09.5114.00
 Ref : 231795



09.5115.00
 Ref : 292759



01.2202.00
 Ref : 372310

REPAIR KIT

15.2011.00

Replaced Old Famco No : FM011001010

Oem Ref	Vehicle/Model	Engine
550044	3 BUS	N113
		D 11
		DS11

15.2021.00

Replaced Old Famco No : FM011201010

Oem Ref	Vehicle/Model	Engine
550167	3 BUS	CP / CR / CT 113
	3 TRUCK	GR / GRS 900 R
		CP 113



WATER PUMP

12.2031.00

Replaced Old Famco No : FM011301000

Oem Ref	Vehicle/Model	Engine
1354103 571150	3 BUS 3 TRUCK	CP / CR / CT 113 GR / GRS 900 R CP 113 GA 850 ALLISON HD4060 P K 113 GR 801 R ZFHP



Package Weight : **8,150 kg**
Package Dimensions : **21x26x27 cm**



03.2202.00
Ref : 278338



01.2203.00
Ref : 270181



09.5114.00
Ref : 231795



09.5115.00
Ref : 292759



09.4012.00
Ref : 363143 (A)
311438 (B)

REPAIR KIT

15.2031.00

Replaced Old Famco No : FM011301010

Oem Ref	Vehicle/Model	Engine
550168	3 BUS 3 TRUCK	CP / CR / CT 113 GR / GRS 900 R CP 113 GA 850

15.2021.00

Replaced Old Famco No : FM011201010

Oem Ref	Vehicle/Model	Engine
550167	3 BUS 3 TRUCK	CP / CR / CT 113 GR / GRS 900 R CP 113 GA 850



FUEL FEED PUMP

32.2010.00

Replaced Old Famco No :

Oem Ref	Vehicle/Model	Engine
1518142	4 Truck	D12
1440235	P-, G-, R-, T Truck	DC12
1436301	F-, K-, N Bus	DT12



Package Weight : **4,200 kg**
 Package Dimensions : **17,5x18,5x16 cm**

FUEL FEED PUMP

32.2020.00

Replaced Old Famco No :

Oem Ref	Vehicle/Model	Engine
2059884	P, G, R, T-Series	DC13
2894842	K,N,F- Series Bus	



Package Weight : **3,600 kg**
 Package Dimensions : **13x15x14 cm**

OIL PUMP

22.2010.00

Replaced Old Famco No :

Oem Ref	Vehicle/Model	Engine
2209509	4 Truck	D11
2028987	P-, G-, R-, T Truck	D12 D12K
1888025	4 Bus	DC11
1448659	F-, K-, N Bus	DC12
1345719	P96 Industrial / Marine	DC12A DI12



Package Weight : **4,100 kg**
Package Dimensions : **21x31x18 cm**

OIL PUMP

22.2020.00

Replaced Old Famco No :

Oem Ref	Vehicle/Model	Engine
2686288	Scania Trucks	DC13
2105497	P, G, R, T Series	OC13
1860961	L, P, G, R Series	D13, K13
1730312	Scania Bus	
	F, K, N Series	
	C, K Series	



Package Weight : **4,750 kg**
Package Dimensions : **21x31x18 cm**

*Special production solutions
for special customers.*



www.famco.com.tr

VOLVO

SCANIA

MERCEDES-BENZ

MAN

DAF

RENAULT

IVECO

OTHERS

EXPORT TO
MORE THAN
45
COUNTRIES



FAMCO[®]
GENUINE

VOLVO

SCANIA

MERCEDES-BENZ

MAN

DAF

RENAULT

IVECO

OTHERS

VOLVO

SCANIA

MERCEDES-BENZ

MAN

DAF

RENAULT

IVECO

OTHERS



CHOICE OF
LEADERS



FAMCO
GENUINE

FA-ME OTOMOTİV DÖKÜM MAKİNE SAN. ve TİC. LTD. ŞTİ.

Büyükkayacık Osb Mah. 5. Org. Sanayi Bölgesi 511 Nolu Sk.
No:13 Selçuklu / KONYA

Phone: +90 332 345 22 55 (pbx) - Fax: +90 332 345 00 15
www.famco.com.tr - sales@fameotomotiv.com



TÜV NORD