

CATALOG

WATER PUMPS
OIL PUMPS
FUEL FEED PUMPS
REPAIR KITS
HOUSINGS
PARTS



FAMCO[®]
GENUINE

2024¹
PRODUCT
CATALOG

www.famco.com.tr

VOLVO

SCANIA

MERCEDES-BENZ

MAN

DAF

RENAULT

IVECO

OTHERS

ABOUT US

Founded in 1967 Fa-Me Automotive, at the beginning of the 2000s started production of water pumps for heavy trucks and commercial vehicles. FAMCO brand, which is being exported to more than 45 countries became one of the preferred brands, because of aiming at improving quality and customer satisfaction.

By following the new technologies, producing with renewed technical equipment and in accordance with ISO9001:2015 certificate, the company is continuing to expand the range of water pumps for VOLVO, DAF, SCANIA, MAN, MERCEDES, RENAULT, IVECO and OTHERS heavy trucks.

*From part to
the Whole...*

OUR MISSION

Our mission is to protect, expand and maintain the superior service concept and quality, and share it with the world as the best in its sector.

OUR VISION

Our vision is to meet the customers expectations and demands quickly and completely, and ensure the continuity of customers satisfaction.

FAMCO IS;

- High technologies;
- Continuous improvement of product and service quality;
- Two-step leakage testing system;
- Quality tested by hundreds of thousands of vehicles all over the world.





PRODUCTION

For today the company is producing more than 150 kinds of water pumps for heavy trucks like IVECO, SCANIA, VOLVO, MAN, MERCEDES, RENAULT, DAF and OTHERS. The product development department is working on expanding the range and satisfying all the needs of our customers.

QUALITY

All products comply with ISO9001:2015 certificate and are covered by an international warranty of 1 year or 100000 km.

Almost all components, except bearing, mechanical seal and raw materials are producing directly at the factory. 92% of suppliers belong to an A-group. The quality control department constantly monitors changes on the market and chooses the most reliable suppliers from a huge variety of offers.

EXPORT

FAMCO is exporting water pumps to more than 45 countries.

Germany
Spain
Estonia
Italy
Greece
Portugal
Poland
The UK
The Netherlands
Belgium

Ireland
Israil
Kyrgyzstan
Russia
South Korea
Colombia
Peru
Chile
Syria
Libya
UAE

Iran
Iraq
Egypt
Yemen
Jordan
Lebanon
Tunisia
South Africa
Ethiopia
Tanzania
Sri Lanka
U.S.A....

VOLVO

SCANIA

MERCEDES-BENZ

MAN

DAF

RENAULT

IVECO

OTHERS

INDEX

for VOLVO	6-37
for SCANIA	38-53
for MERCEDES-BENZ	54-97
for MAN	98-129
for DAF	130-147
for RENAULT	148-171
for IVECO	172-186
for OTHERS	187-192

VOLVO

SCANIA

MERCEDES-BENZ

MAN

DAF

RENAULT

IVECO

OTHERS

VOLVO

SCANIA

MERCEDES-BENZ

MAN

DAF

RENAULT

IVECO

OTHERS

FOR MERCEDES-BENZ



www.famco.com.tr



WATER PUMP

12.3230.00

Replaced Old Famco No : FM262201000

Oem Ref	Vehicle/Model	Engine
4032007101		OM 401 A
4032005101		OM 402/A
4032004401		OM 403
		OM 404 A
		OM 407/A/AH/H/HA/LA
		OM 421/ A/LA
		OM 422/ A/LA
		OM 423/ A/LA...

*impeller: ø 125 mm width: 12 mm



Package Weight : **11,600 kg**
Package Dimensions : **24x40x16 cm**



03.1403.00
Ref : 4032020414



09.2328.00
Ref : 4032001802



09.4004.00
Ref : 0012011919



01.2305.00
Ref : 4032011307
Ø 125x15 12 mm



16.3230.00

REPAIR KIT

15.3230.00

Replaced Old Famco No : FM260001010

Oem Ref	Vehicle/Model	Engine
4222000604	F 10	OM 401 A
4222000104	N 10v	OM 402/A
4222000304	NL 10/S	OM 403
4232000104	N 10 Mark II	OM 404 A
4232000004		OM 407/A/AH/H/HA/LA
		OM 421/ A/LA
		OM 422/ A/LA
		OM 423/ A/LA
		OM 424/ A/LA
		OM 427/ A/H/HA/LA
		OM OM/ 441/ A/LA
		OM 442/ A/LA
		OM 443
		OM 444
		OM 447/A/H/HA/LA

*impeller: ø 125 mm width: 12 mm

Remarks

to fit water pumps:
403 200 4401 403 200 7101
403 200 5101
403 200 7601
403 200 7701

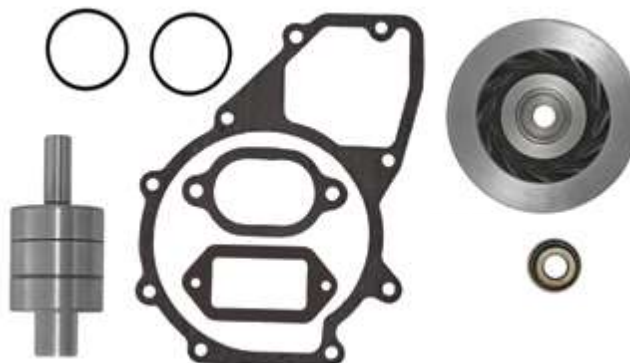

WATER PUMP

12.3340.00

Replaced Old Famco No : FM042311000

Oem Ref	Vehicle/Model	Engine
4222001001		OM 423/ A/LA
4222000501		OM 443 LA OM 444

*impeller: \varnothing 135 mm (closed)

Package Weight : **11,750 kg**
 Package Dimensions : **24x40x16 cm**



03.1403.00
 Ref : 4032020414



09.2328.00
 Ref : 4032001902



09.5137.00
 Ref : 4032010480
 4422010480



01.2307.00
 Ref : 4222010207
 \varnothing 135x15 mm (closed)



09.5134.00
 Ref : 4032011080
 4422010080

REPAIR KIT

15.3250.00

Replaced Old Famco No : FM042301010

Oem Ref	Vehicle/Model	Engine
4222000504		OM 401/A
4222000404		OM 402/A
4222000204		OM 403
4222000004		OM 407/A/AH/H/HA/LA
		OM 421/A/LA
		OM 422/A/LA
		OM 423/A/LA
		OM 424/A/LA
		OM 427/A/H/HA/LA
		OM 441/A/LA
		OM 422/A/LA
		OM 443
		OM 444
		OM 447/A/H/HA/LA

*impeller: \varnothing 135 mm (closed)Remarks

to fit water pumps:

422 200 1001
 422 200 0501
 422 200 1401
 422 200 1301



WATER PUMP

12.3231.00

Replaced Old Famco No : FM262211000

Oem Ref	Vehicle/Model	Engine
4032007701		OM 401/A
4032007601		OM 402/A
		OM 403
		OM 407/A/AH/H/HA/LA
		OM 421/A/LA
		OM 422/A/LA
		OM 423/A/LA
		OM 424/A/LA
		OM 427/A/H/HA/LA
		OM 441/A/LA
		OM 422/A/LA...

*impeller: ø 125 mm width: 12 mm



Package Weight : **11,650 kg**
Package Dimensions : **24x40x16 cm**



03.1403.00
Ref : 4032020414



09.2328.00
Ref : 4032001902



09.4004.00
Ref : 0012012619



01.2305.00
Ref : 4032011307
Ø125x15 12 mm



09.5136.00
Ref : 4422010380

GASKET SET

16.3250.00

Replaced Old Famco No :

Oem Ref	Vehicle/Model	Engine
4032006901		
4032000260		



WATER PUMP

12.3250.00

Replaced Old Famco No : FM042301000

Oem Ref	Vehicle/Model	Engine
4222001401		OM 423 LA
4222001301		OM 443 LA

*impeller: \varnothing 135 mm (closed)

Package Weight : **11,650 kg**
 Package Dimensions : **24x40x16 cm**

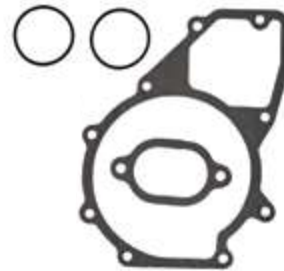

03.1403.00
 Ref : 4032020414



09.2328.00
 Ref : 4032001902



09.4004.00
 Ref : 0012012619



01.2307.00
 Ref : 4222010207
 \varnothing 135 x 15 mm (closed)

REPAIR KIT

15.3250.00

Replaced Old Famco No : FM042301010

Oem Ref	Vehicle/Model	Engine
4222000504		OM 401/A
4222000404		OM 402/A
4222000204		OM 403
4222000004		OM 407/A/AH/H/HA/LA
		OM 421/A/LA
		OM 422/A/LA
		OM 423/A/LA
		OM 424/A/LA
		OM 427/A/H/HA/LA
		OM 441/A/LA
		OM 422/A/LA
		OM 443
		OM 444
		OM 447/A/H/HA/LA

*impeller: \varnothing 135 mm (closed)Remarks

to fit water pumps:

422 200 1001
 422 200 0501
 422 200 1401
 422 200 1301



WATER PUMP

12.3270.00

Replaced Old Famco No : FM262231000

Oem Ref	Vehicle/Model	Engine
4412000201	441.900	OM 441
4412000101	441.920	OM 441
	440.907, 909	OM 442
	442.900, 905	OM 442
	442.920	OM 442

*impeller: ø 125 mm width: 8 mm



Package Weight : **11,650 kg**
Package Dimensions : **24x40x16 cm**



03.1403.00
Ref : 4032020414



09.2328.00
Ref : 4032001902



09.4004.00
Ref : 0012012619



01.2304.00
Ref : 4412010207
Ø 125x15 8 mm

REPAIR KIT

15.3260.00

Replaced Old Famco No : FM260021010

Oem Ref	Vehicle/Model	Engine
	441.900 – 919	OM 441
	from engine: 504520	OM 441
	441.920 – 933	OM 442
	from engine: 504520	OM 442
	440.907, 909	OM 442
	442.900, 905 – 919	OM 442
	from engine: 504398	OM 442
	442.920 – 939	OM 442
	from engine: 504398	OM 442

*impeller: ø 125 mm width: 8 mm

Remarks

to fit water pumps:

- 441 200 0301
- 441 200 0201
- 441 200 0101

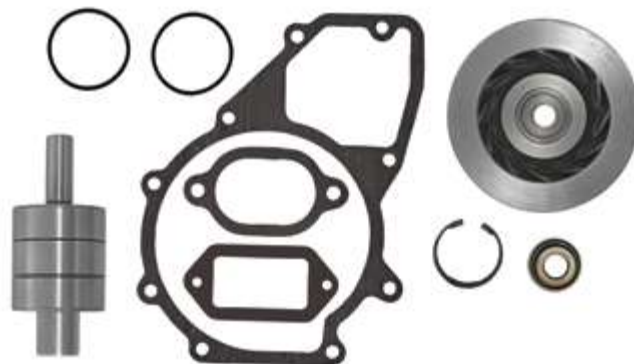

WATER PUMP

12.3070.00

Replaced Old Famco No : FM184001000

Oem Ref	Vehicle/Model	Engine
4572002301	AXOR	OM 457
4572000801		OM 458

*impeller: \varnothing 125 mm width: 8 mm

Package Weight : **11,700 kg**
 Package Dimensions : **24x40x16 cm**

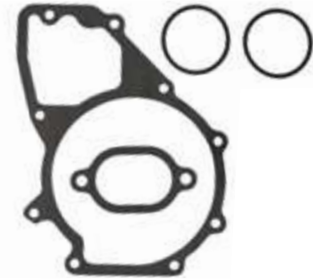

03.1403.00
 Ref : 5422020114



09.2328.00
 Ref : 0002000002
 4422000102



09.5128.00
 Ref : 4572010080
 (Paper Gasket)



01.2304.00
 Ref : 4412010207
 \varnothing 125x15 8mm



16.3080.00

REPAIR KIT

15.3070.00

Replaced Old Famco No : FM184001010

Oem Ref	Vehicle/Model	Engine
4412000204	AXOR	OM 457
4412000104		OM 458
4572000004		

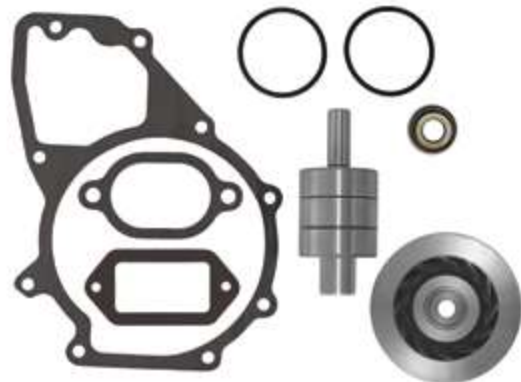
*impeller: \varnothing 125 mm width: 8 mm

WATER PUMP

12.3100.00

Replaced Old Famco No : FM184041000

Oem Ref	Vehicle/Model	Engine
4572002901	AXOR	OM 457 OM 458

*impeller: ø 125 mm width: 8 mm

*with metal gasket



Package Weight : **11,760 kg**
Package Dimensions : **24x40x16 cm**

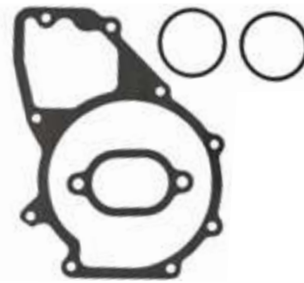

03.1403.00
Ref : 5422020114



09.2328.00
Ref : 0002000002
4422000102



09.5129.00
Ref : 4572010380
(Metal Gasket)



01.2304.00
Ref : 4412010207
Ø 125x15 8 mm

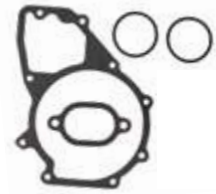

16.3100.00
(Metal Gasket)

GASKET KIT

16.3070.00

Replaced Old Famco No : FM184001009

Oem Ref	Vehicle/Model	Engine
4572000401		
4572000301		

*with metal gasket



WATER PUMP

12.3260.00

Replaced Old Famco No : FM262241000

Oem Ref	Vehicle/Model	Engine
4412000301	441.900 – 919 from engine: 504520 442.900, 905 – 919 from engine: 504398	OM 440 OM 441 OM442

*impeller: \varnothing 125 mm width: 8 mm

Package Weight : **11,600 kg**
 Package Dimensions : **24x40x16 cm**



03.1403.00
Ref : 5422020114



09.2328.00
Ref : 0002000002
4422000102



09.4004.00
Ref : 0012012619



01.2304.00
Ref : 4412010207
 \varnothing 125x15 8 mm

REPAIR KIT

15.3260.00

Replaced Old Famco No : FM260021010

Oem Ref	Vehicle/Model	Engine
	441.900 – 919 from engine: 504520 441.920 – 933 from engine: 504520 440.907, 909 442.900, 905 – 919 from engine: 504398 442.920 – 939 from engine: 504398	OM 441 OM 441 OM 442 OM 442 OM 442

*impeller: \varnothing 125 mm width: 8 mmRemarks

to fit water pumps:

441 200 0301
 441 200 0201
 441 200 0101

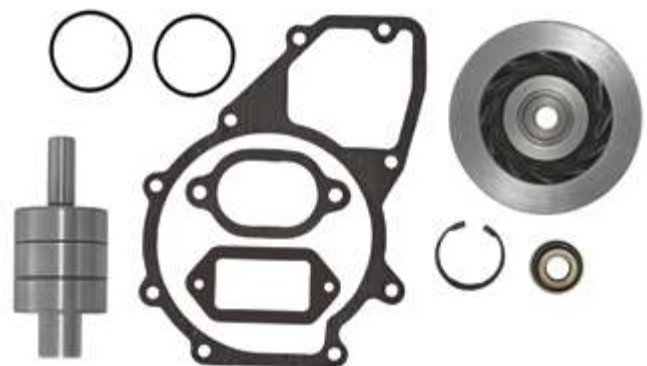

WATER PUMP

12.3150.00

Replaced Old Famco No : FM184821000

Oem Ref	Vehicle/Model	Engine
5422002201	ACTROS	OM 502 LA
5422001801	420kW 542.924 448kW 542.956	

*impeller: ø 125 mm width: 12 mm



Package Weight : **15,100 kg**
Package Dimensions : **24x40x21 cm**



02.2302.00



09.2329.00



09.5135.00
Ref : 5412010280
9425010080



01.2305.00
Ref : 5422010007
Ø 125x15 12mm



16.3141.00

REPAIR KIT

15.3150.00

Replaced Old Famco No : FM184821010

Oem Ref	Vehicle/Model	Engine
	ACTROS	OM 502 LA
	420kW 542.924 448kW 542.956	

*impeller: ø 125 mm width: 12 mm

Remarks

to fit water pumps:

5422002201
5422001801
5422002601



WATER PUMP

12.3071.00

Replaced Old Famco No : FM184011000

Oem Ref	Vehicle/Model	Engine
4572000101	AXOR	OM 457 LA
4752000201	265kW 457.925	OM 458 LA
4752000101	320kW 457.922	
4572001601		

*impeller: \varnothing 125 mm width: 12 mm

Package Weight : **11,700 kg**
 Package Dimensions : **24x40x16 cm**

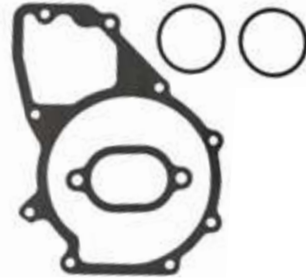

03.1403.00
 Ref : 5422020114



09.2328.00
 Ref : 0002000002
 4422000102



09.4004.00
 Ref : 0012012619



01.2305.00
 Ref : 4032011307
 \varnothing 125x15 12mm

REPAIR KIT

16.3071.00

Replaced Old Famco No :

Oem Ref	Vehicle/Model	Engine
4222000060		
4222000901		



WATER PUMP

12.3130.00

Replaced Old Famco No : FM184071000

Oem Ref	Vehicle/Model	Engine
4602003001		OM 457 LA - 457.937
4602002801		OM 457 LA - 457.939
4572000601		OM 457 LA - 457.943 OM 457 LA - 458.910

*impeller: ø 125 mm width: 12 mm

*with metal gasket



Package Weight : **12,000 kg**
Package Dimensions : **24x40x16 cm**

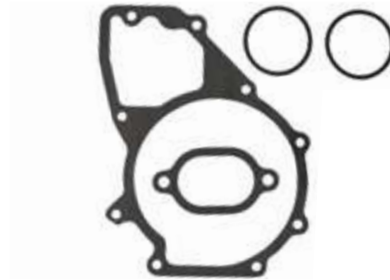

03.1403.00
Ref : 5422020114



09.2328.00
Ref : 0002000002
4422000102



09.4004.00
Ref : 0012012619



01.2305.00
Ref : 4032011307
Ø 125x15 12mm



09.5129.00
Ref : 4572010380
(Metal Gasket)

REPAIR KIT

15.3080.00

Replaced Old Famco No : FM184021010

Oem Ref	Vehicle/Model	Engine
4572000104	AXOR	OM 457 OM 458

*impeller: ø 125 mm width: 12 mm

*with metal gasket



WATER PUMP

12.3170.00

Replaced Old Famco No : FM184841000

Oem Ref	Vehicle/Model	Engine
5422002101	ACTROS	OM 501 LA OM 502 LA
	541.920, 926	
	541.940, 941	
	541.951	
	541.922, 927	
	941.920	
	541.942, 943	
	541.923, 924	
	941.981	
	541.944, 945	
	541.921, 925	
	941.990	
	541.946, 947	
	541.948	

*impeller: ø 125 mm width: 12 mm



Package Weight : **14,550 kg**
 Package Dimensions : **24x40x21 cm**

**02.2302.00****09.2329.00**

09.4004.00
 Ref : 0012012619



01.2305.00
 Ref : 5422010007
 Ø 125x15 12mm

**16.3170.00**

REPAIR KIT

15.3170.00

Replaced Old Famco No : FM184841010

Oem Ref	Vehicle/Model	Engine
	ACTROS	OM 502 LA
	420kW 542.924	
	448kW 542.956	

*impeller: ø 125 mm width:12 mm



WATER PUMP

12.3072.00

Replaced Old Famco No : FM184801000

Oem Ref	Vehicle/Model	Engine
5412001201	ACTROS	OM 501 LA
5412001101	315kW 521.940	
5412000101	230kW 541.920	
	315kW 541.921	
	260kW 541.922	
	290kW 541.923	
	315kW 541.925	
	355kW 541.948	
	230kW 941.910	
	290kW 941.929	
	300kW 941.930	
	230kW 941.960	
	290kW 941.980	
	315kW 941.990	

*impeller: ø 125 mm width: 8 mm



Package Weight : **12,300 kg**
Package Dimensions : **24x40x16 cm**



03.1403.00
Ref : 5422020114



09.2328.00
Ref : 4422000102



09.4004.00
Ref : 0012012619



01.2304.00
Ref : 4412010207
Ø 125x15 8mm



09.5124.00
Ref : 5422010080
(Paper Gasket)

REPAIR KIT

15.3072.00

Replaced Old Famco No : FM180001010

Oem Ref	Vehicle/Model	Engine
5412000004	ACTROS	OM 501 LA
	315kW 521.940	
	230kW 541.920	
	315kW 541.921	
	260kW 541.922	
	290kW 541.923	
	315kW 541.925	
	355kW 541.948	
	230kW 941.910	

*impeller: ø 125 mm width: 8 mm

Remarks

to fit water pumps:
5412001201 5412001401
5412001101
5412000101



WATER PUMP

12.3160.00

Replaced Old Famco No : FM184831000

Oem Ref	Vehicle/Model	Engine
5422001901	ACTROS	OM 501 LA
5422001501	315kW 521.940	OM 502 LA
5422000501	230kW 541.920	
	315kW 541.921	
	260kW 541.922	
	290kW 541.923	
	315kW 541.925	
	355kW 541.948	
	230kW 941.910	
	290kW 941.929	
	300kW 941.930	
	230kW 941.960	
290kW 941.980		
315kW 941.990		

*impeller: \varnothing 125 mm width: 12 mm

Package Weight : **11,950 kg**
 Package Dimensions : **24x40x16 cm**



03.1403.00
 Ref : 5422020114



09.2328.00
 Ref : 4422000102



09.4004.00
 Ref : 0012012619



01.2305.00
 Ref : 5422010007
 \varnothing 125x15 12mm

GASKET KIT

16.3180.00

Replaced Old Famco No : FM180001009

Oem Ref	Vehicle/Model	Engine
5422000701		

* with metal gasket

Remarks

to fit water pumps:
 542 200 1901 542 200 2001
 542 200 1501 542 200 1601
 542 200 0501 542 200 0601
 542 200 2401



WATER PUMP

12.3141.00

Replaced Old Famco No : FM184811000

Oem Ref	Vehicle/Model	Engine
5422002001	ACTROS	OM 501 LA
5422001601	With Retarder	OM 502 A
5422000601		
5412001001		

*impeller: ø 125 mm width: 12 mm



Package Weight : **12,650 kg**
Package Dimensions : **24x40x16 cm**



03.1403.00
Ref : 5422020114



09.2328.00
Ref : 4422000102



09.4004.00
Ref : 0012012619



01.2305.00
Ref : 5422010007
Ø 125x15 12mm

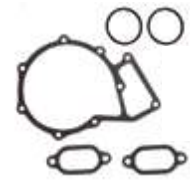

16.3141.00

REPAIR KIT

15.3141.00

Replaced Old Famco No : FM180011010

Oem Ref	Vehicle/Model	Engine
5422000004	ACTROS	OM 501 LA
	315kW 521.940	OM 502 LA
	230kW 541.920	
	315kW 541.921	
	260kW 541.922	
	290kW 541.923	
	315kW 541.925	
	355kW 541.948	
	230kW 941.910	

*impeller: ø 125 mm width: 12 mm

Remarks

to fit water pumps:
542 200 1901 542 200 2001
542 200 1501 542 200 1601
542 200 0501 542 200 0601



WATER PUMP

12.3010.00

Replaced Old Famco No : FM151701000

Oem Ref	Vehicle/Model	Engine
9042004901	ATEGO	OM 904 LA
9042002601		OM 906 LA/HLA/LAG
9042000801		OM 924 LA
9042000401		
9042004301		
9042003801		
9042003201		
9042002201		
9042002001		
9042001901		
9042000701		
9042000201		
9042002501		



Package Weight : **10,400 kg**
 Package Dimensions : **24x40x16 cm**



03.1301.00
 Ref : 9042020014



09.2328.00
 Ref : 4422000102



09.9002.00
 Ref : 9062030015



09.4004.00
 Ref : 0012012619



01.2302.00
 Ref : 9062010007

REPAIR KIT

15.3010.00

Replaced Old Famco No : FM151701010

Oem Ref	Vehicle/Model	Engine
9042000004	ATEGO	OM 904 LA
9062000004		OM 906 LA/HLA/LAG
9042000204		OM 924 LA



WATER PUMP

12.3030.00

Replaced Old Famco No : FM151731000

Oem Ref	Vehicle/Model	Engine
9042005101		OM 904 LA - 900.911
9042004701		OM 904 LA - 900.912
		OM 904 LA - 900.913
		OM 904 LA - 900.915

*with two threads M14x1.5



Package Weight : **10,400 kg**
Package Dimensions : **24x40x16 cm**



03.1301.00
Ref : 9042020014



09.5162.00
Ref : 9062030176



09.5127.00
Ref : 9062030180



16.3030.00



09.5126.00
Ref : 9062010080

GASKET KIT

16.3010.00

Replaced Old Famco No : FM151701009

Oem Ref	Vehicle/Model	Engine
9042001201	ATEGO	OM 904 LA
9042001101		OM 906 LA/HLA/LAG
9062001001		OM 924 LA
9042000501		



WATER PUMP

12.3280.00

Replaced Old Famco No : FM151761000

Oem Ref	Vehicle/Model	Engine
9042005001		OM 904 LA
9042004601		OM 906 LA
9042002901		OM 924 LA
9042002701		
9042002401		



Package Weight : **10,600 kg**
 Package Dimensions : **24x40x16 cm**

**03.1303.00****09.2315.00****03.2302.00****09.9002.00**
Ref : 9062030415**01.2302.00**
Ref : 9062010007

REPAIR KIT

15.3280.00

Replaced Old Famco No : FM151761010

Oem Ref	Vehicle/Model	Engine
9042000404		OM 904 LA OM 906 LA OM 924 LA



WATER PUMP

12.3300.00

Replaced Old Famco No : FM151781000

Oem Ref	Vehicle/Model	Engine
9042005301		OM 904 LA



Package Weight : **10,600 kg**
Package Dimensions : **24x40x16 cm**



03.1303.00



09.2315.00



03.2302.00



09.9002.00
Ref : 9062030615



01.2302.00
Ref : 9062010007

REPAIR KIT

15.3280.00

Replaced Old Famco No : FM151761010

Oem Ref	Vehicle/Model	Engine
9042000404		OM 904 LA OM 906 LA OM 924 LA



WATER PUMP

12.3080.00

Replaced Old Famco No : FM184021000

Oem Ref	Vehicle/Model	Engine
4572002501	AXOR	OM 457
4572000501	Back Side	OM 458
4572000201	Hole 20 mm	

*impeller: ø 125 mm width: 12 mm



Package Weight : **12,250 kg**
 Package Dimensions : **24x40x16 cm**



03.1403.00
 Ref : 5422020114



09.2328.00
 Ref : 4032001802



09.4004.00
 Ref : 0012012619



01.2305.00
 Ref : 4032011307
 Ø 125x15 12mm



16.4180.00

REPAIR KIT

15.3071.00

Replaced Old Famco No : FM184011010

Oem Ref	Vehicle/Model	Engine
	AXOR	OM 457 LA
	265kW 457.925	OM 458 LA
	320kW 457.922	

*impeller: ø 125 mm width:12 mm



WATER PUMP

12.3110.00

Replaced Old Famco No : FM184051000

Oem Ref	Vehicle/Model	Engine
4572002701	AXOR Back Side Hole 20 mm	OM 457 OM 458

*impeller: ø 125 mm width: 12 mm

*with metal gasket



Package Weight : **12,400 kg**
Package Dimensions : **24x40x16 cm**



03.1403.00
Ref : 5422020114



09.2328.00
Ref : 4032001802



09.5136.00
Ref : 4422010380



01.2305.00
Ref : 4032011307
Ø 125x15 12mm



16.3110.00
(Metal Gasket)

REPAIR KIT

15.3080.00

Replaced Old Famco No : FM184021010

Oem Ref	Vehicle/Model	Engine
4572000104	AXOR	OM 457 OM 458

*impeller: ø 125 mm width: 12 mm

*with metal gasket



WATER PUMP

12.3220.00

Replaced Old Famco No : FM251701000

Oem Ref	Vehicle/Model	Engine
3662005901	366.901	OM 366
3662000901	366.941	OM 366A
3662000401	366.970	OM 366LA
	357.930	OM 366LA EURO II

*without cover



Package Weight : **6,450 kg**
 Package Dimensions : **21x31x18 cm**



02.2301.00
 Ref : 3522010039



03.2303.00
 Ref : 3662010205



06.1301.00
 Ref : 3662000204



09.5161.00
 Ref : 3662010180



09.5133.00
 Ref : 3642010280



16.3220.00

REPAIR KIT

15.3220.00

Replaced Old Famco No : FM251701010

Oem Ref	Vehicle/Model	Engine
3662000804	366.901	OM 366
3662000604	366.941	OM 366A
3662000304	366.970	OM 366LA
3662000004	357.930	OM 366LA EURO II



WATER PUMP

12.3240.00

Replaced Old Famco No : FM262221000

Oem Ref	Vehicle/Model	Engine
4032007301	O 303	OM 402 LA EURO I
4032005301	O 330	OM 407/H/A/LA/HA
4032004701	O 305 G	OM 427 A/LA/HA
	O 405	OM 427/H
		OM 441A/LA
		OM 447 HLA EURO II
		OM 447 A/LA/HA

*impeller: ø 125 mm width: 12 mm



Package Weight : **12,350 kg**
Package Dimensions : **24x40x16 cm**



03.1403.00
Ref : 4032020414



09.2328.00
Ref : 4032001802



09.4004.00
Ref : 0012012619



01.2305.00
Ref : 4032011307
Ø 125x15 12mm

REPAIR KIT

15.3230.00

Replaced Old Famco No : FM260001010

Oem Ref	Vehicle/Model	Engine
4222000604	F 10	OM 401 A
4222000104	N 10v	OM 402/A
4222000304	NL 10/S	OM 403
4232000104	N 10 Mark II	OM 404 A
4232000004		OM 407/A/AH/H/HA/LA
		OM 421/ A/LA
		OM 422/ A/LA
		OM 423/ A/LA
		OM 424/ A/LA
		OM 427/ A/H/HA/LA
		OM OM/ 441/ A/LA
		OM 442/ A/LA
		OM 443
		OM 444
		OM 447/A/H/HA/LA

*impeller: ø 125 mm width: 12 mm

Remarks
to fit water pumps:
403 200 4401 403 200 7101
403 200 5101
403 200 7601
403 200 7701

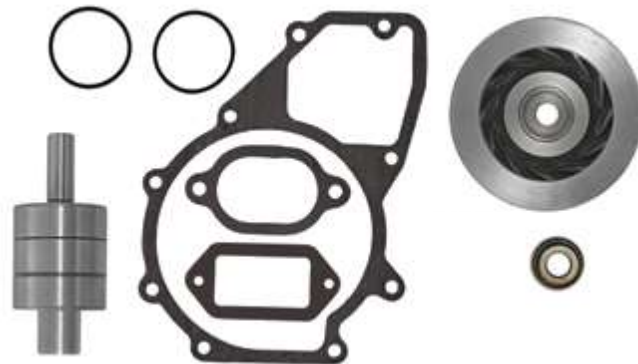

WATER PUMP

12.3090.00

Replaced Old Famco No : FM184031000

Oem Ref	Vehicle/Model	Engine
4572002401	AXOR	OM 457
4572001801	Back Side	OM 458
4572001001	Hole Closed	
4572000901		

*impeller: \varnothing 125 mm width: 12 mm

Package Weight : **12,500 kg**
 Package Dimensions : **24x40x16 cm**



03.1403.00
 Ref : 4032020414



09.2328.00
 Ref : 4032001802



09.4004.00
 Ref : 0012012619



01.2305.00
 Ref : 4032011307
 \varnothing 125x15 12mm

REPAIR KIT

15.3071.00

Replaced Old Famco No : FM184011010

Oem Ref	Vehicle/Model	Engine
	AXOR	OM 457 LA
	265kW 457.925	OM 458 LA
	320kW 457.922	

*impeller: \varnothing 125 mm width:12 mm

WATER PUMP

12.3120.00

Replaced Old Famco No : FM184061000

Oem Ref	Vehicle/Model	Engine
4572002801		OM 457 LA - 457.907 OM 457 LA - 457.908 OM 457 LA - 457.909 OM 457 LA - 457.915

*impeller: ø 125 mm width: 12 mm

*with metal gasket



Package Weight : **12,500 kg**
Package Dimensions : **24x40x16 cm**



03.1403.00
Ref : 4032020414



09.2328.00
Ref : 4032001802



09.4004.00
Ref : 0012012619



01.2305.00
Ref : 4032011307
Ø 125x15 12mm

REPAIR KIT

15.3080.00

Replaced Old Famco No : FM184021010

Oem Ref	Vehicle/Model	Engine
4572000104	AXOR	OM 457 OM 458

*impeller: ø 125 mm width: 12 mm

*with metal gasket



WATER PUMP

12.3020.00

Replaced Old Famco No : FM042321000

Oem Ref	Vehicle/Model	Engine
4222001101		OM 401 / A
4222000601		OM 402 / A
4222001601		OM 403
4222001801		OM 407 / A / AH / H / HA / LA
		OM 421 / A / LA
		OM 422 / A / LA
		OM 423 / A / LA
		OM 424 / A / LA
		OM 427 / A / H / HA / LA...

*impeller: \varnothing 135 mm

Package Weight : **12,450 kg**
 Package Dimensions : **24x40x16 cm**



03.1403.00
 Ref : 4032020414



09.2328.00
 Ref : 4032001802



09.4004.00
 Ref : 0012012619



01.2306.00
 \varnothing 135 mm

REPAIR KIT

15.3251.00

Replaced Old Famco No :

Oem Ref	Vehicle/Model	Engine
		OM 401 / A
		OM 402 / A
		OM 403
		OM 407 / A / AH / H / HA / LA
		OM 421 / A / LA
		OM 422 / A / LA
		OM 423 / A / LA
		OM 424 / A / LA
		OM 427 / A / H / HA / LA
		OM 441 / A / LA
		OM 442 / A / LA
		OM 443
		OM 444
		OM 447 / A / H / HA / LA

*impeller: \varnothing 135 mm

WATER PUMP

12.3180.00

Replaced Old Famco No : FM184851000

Oem Ref	Vehicle/Model	Engine
5412001401	ACTROS	OM 501 LA
	315kW 521.940	
	230kW 541.920	1831 – 3331
	315kW 541.921	1843 – 3343
	260kW 541.922	
	290kW 541.923	
	315kW 541.925	
	355kW 541.948	
	230kW 941.910	
	290kW 941.929	
	300kW 941.930	
	230kW 941.960	
	290kW 941.980	
	315kW 941.990	

*impeller: ø 125 mm width: 8 mm

*with metal gasket



Package Weight : **12,500 kg**
Package Dimensions : **24x40x16 cm**



03.1403.00
Ref : 4032020414



09.2328.00
Ref : 4032001802



09.5125.00
Ref : 5422010180
(Metal Gasket)



01.2304.00
Ref : 4412010207
Ø 125x15 8 mm



09.1527.00
Ref : 0249972848



16.3181.00
(Metal Gasket)

REPAIR KIT

15.3180.00

Replaced Old Famco No : FM180031010

Oem Ref	Vehicle/Model	Engine
	ACTROS	OM 501 LA
	315kW 521.940	
	230kW 541.920	
	315kW 541.921	
	260kW 541.922	
	290kW 541.923	
	315kW 541.925	

*impeller: ø 125 mm width: 8 mm

*with metal gasket

Remarks

to fit water pumps:
5412001201 5412001401
5412001101
5412000101



WATER PUMP

12.3181.00

Replaced Old Famco No :

Oem Ref	Vehicle/Model	Engine
5422002301	ACTROS	OM 501 LA
	315kW 521.940	
	230kW 541.920	1831 – 3331
	315kW 541.921	1843 – 3343
	260kW 541.922	
	290kW 541.923	
	315kW 541.925	
	355kW 541.948	
	230kW 941.910	
	290kW 941.929	
	300kW 941.930	
	230kW 941.960	
	290kW 941.980	
	315kW 941.990	

*impeller: \varnothing 125 mm width: 12 mm

*with metal gasket



Package Weight : **12,500 kg**
 Package Dimensions : **24x40x16 cm**



03.1403.00
 Ref : 4032020414



09.2328.00
 Ref : 4032001802



09.5125.00
 Ref : 5422010180
 (Metal Gasket)



01.2305.00
 Ref : 5422010007
 \varnothing 125x15 12mm



09.1527.00
 Ref : 0249972848



16.3181.00
 (Metal Gasket)

REPAIR KIT

15.3181.00

Replaced Old Famco No : FM180031010

Oem Ref	Vehicle/Model	Engine
	ACTROS	OM 501 LA
	315kW 521.940	
	230kW 541.920	
	315kW 541.921	
	260kW 541.922	
	290kW 541.923	
	315kW 541.925	

*impeller: \varnothing 125 mm width: 12 mm

*with metal gasket

Remarks

to fit water pumps:
 5412001201 5412001401
 5412001101
 5412000101



WATER PUMP

12.3190.00

Replaced Old Famco No : FM184861000

Oem Ref	Vehicle/Model	Engine
5422002401	ACTROS With Retarder	OM 501 LA OM 502 A
	230 kW	541.920
	315 kW	541.921
	260 kW	541.922
	290 kW	541.923, 924
	315 kW	541.925
	230 kW	541.926
	260 kW	541.927
	230 kW	541.940, 941
	260 kW	541.942, 943
	290 kW	541.944, 945
	315 kW	541.946, 947
	355 kW	541.948

*impeller: ø 125 mm width: 12 mm

*with metal gasket



Package Weight : **11,600 kg**
Package Dimensions : **24x40x16 cm**



03.1403.00
Ref : 4032020414



09.2328.00
Ref : 4032001802



09.4004.00
Ref : 0012012619



01.2305.00
Ref : 5422010007
Ø 125x15 12mm



16.3190.00
(Metal Gasket)

REPAIR KIT

15.3190.00

Replaced Old Famco No : FM180021010

Oem Ref	Vehicle/Model	Engine
5422000104	ACTROS	OM 501 LA OM 502 LA
	315kW	521.940
	230kW	541.920
	315kW	541.921
	260kW	541.922

*impeller: ø 125 mm width: 12 mm

*with metal gasket

Remarks

to fit water pumps:

- 542 200 1901 542 200 2001
- 542 200 1501 542 200 1601
- 542 200 0501 542 200 0601
- 542 200 2401



WATER PUMP

12.3011.00

Replaced Old Famco No : FM151711000

Oem Ref	Vehicle/Model	Engine
9062006101		OM 904 LA
9062006701		OM 906 LA / HLA
		OM 924 LA
		OM 926 LA
		M 906 LAG



Package Weight : **10,750 kg**
 Package Dimensions : **24x40x16 cm**

**03.1303.00**

09.2315.00
 Ref : 4149810205

**03.2302.00**

09.9002.00
 Ref : 9062030615



01.2303.00
 Ref : 9062010107

REPAIR KIT

15.3011.00

Replaced Old Famco No : FM151711010

Oem Ref	Vehicle/Model	Engine
9062000304		OM 904 LA
		OM 906 LA / HLA
		OM 924 LA
		OM 926 LA
		M 906 LAG

Remarks

to fit water pumps:

906 200 6101	906 200 3801	906 200 1401	906 200 3701
906 200 6501	906 200 2901	906 200 1301	906 200 2601
906 200 5701	906 200 2801	906 200 0901	906 200 6201
906 200 5401	906 200 2201	906 200 5501	



WATER PUMP

12.3290.00

Replaced Old Famco No : FM151771000

Oem Ref	Vehicle/Model	Engine
9062006401		OM 904 LA - 904.925
9062004801		OM 904 LA - 904.945
9062004201		OM 904 LA - 904.962
9062003201		OM 904 LA - 904.965
9062002401		
9062001801		



Package Weight : **10,500 kg**
Package Dimensions : **24x40x16 cm**



03.1301.00



09.2328.00
Ref : 4032001802



09.9002.00
Ref : 9062030615



09.4004.00
Ref : 0012012619



01.2303.00
Ref : 9062010107

REPAIR KIT

15.3290.00

Replaced Old Famco No : FM151771010

Oem Ref	Vehicle/Model	Engine
9062000204		
9062000104		



WATER PUMP

12.3040.00

Replaced Old Famco No : FM151741000

Oem Ref	Vehicle/Model	Engine
9062006501		OM 904 LA - 904.925
9062005801		OM 904 LA - 904.928
9062005701		OM 904 LA - 904.932
9062005401		OM 904 LA - 904.945
9062003801		
9062002901		
9062002201		
9062001401		
9062001301		
9062000901		



Package Weight : **10,750 kg**
 Package Dimensions : **24x40x16 cm**

**03.1303.00**

09.2315.00
 Ref : 4149810205

**03.2302.00**

09.9002.00
 Ref : 9062030615



01.2303.00
 Ref : 9062010107

GASKET KIT

16.3010.00

Replaced Old Famco No : FM151701009

Oem Ref	Vehicle/Model	Engine
9042001201	ATEGO	OM 904 LA
9042001101		OM 906 LA/HLA/LAG
9062001001		OM 924 LA
9042000501		



WATER PUMP

12.3060.00

Replaced Old Famco No : FM151791000

Oem Ref	Vehicle/Model	Engine
9062006201		OM 904 LA -904.915
9062005501		OM 904 LA -904.932
9062003701		OM 904 LA -904.939
9062002801		OM 904 LA -904.940
9062002801		OM 904 LA -904.946
9062004901		OM 904 LA -904.947
		OM 904 LA -904.954
		OM 904 LA -904.956
		OM 904 LA -904.971
		OM 904 LA -904.975
		OM 906 LA -902.970
		OM 906 LA -906.911
		OM 906 LA -906.915
		OM 906 LA -906.929
		OM 906 LA -906.932
		OM 906 LA -906.933
		OM 906 LA -906.944
		OM 906 LA -906.945
		OM 906 LA -906.946
		OM 906 LA -906.947
		OM 906 LA -906.948
		OM 906 LA -906.949
		OM 906 LA -906.950



Package Weight : **10,750 kg**
Package Dimensions : **24x40x16 cm**



03.1303.00



09.2315.00
Ref : 4149810205



03.2302.00



09.9002.00
Ref : 9062030615



01.2303.00
Ref : 9062010107

REPAIR KIT

15.3011.00

Replaced Old Famco No : FM151711010

Oem Ref	Vehicle/Model	Engine
9062000304		OM 904 LA OM 906 LA / HLA OM 924 LA OM 926 LA M 906 LAG

Remarks

to fit water pumps:

906 200 6101	906 200 3801	906 200 1401	906 200 3701
906 200 6501	906 200 2901	906 200 1301	906 200 2601
906 200 5701	906 200 2801	906 200 0901	906 200 6201
906 200 5401	906 200 2201	906 200 5501	



WATER PUMP

12.3021.00

Replaced Old Famco No : FM151721000

Oem Ref	Vehicle/Model	Engine
9062006001		OM 904 LA
9062005201		OM 906 LA / HLA
9062002701		OM 924 LA
9062002601		OM 926 LA
		M 906 LAG



Package Weight : **10,550 kg**
 Package Dimensions : **24x40x16 cm**

**03.1401.00****09.2314.00**
Ref : 1689810727**03.2301.00****09.9002.00**
Ref : 9062030615**01.2303.00**
Ref : 9062010107

REPAIR KIT

15.3021.00

Replaced Old Famco No : FM151721010

Oem Ref	Vehicle/Model	Engine
		OM 904 LA
		OM 906 LA / HLA
		OM 924 LA
		OM 926 LA
		M 906 LAG



WATER PUMP

12.3050.00

Replaced Old Famco No : FM151751000

Oem Ref	Vehicle/Model	Engine
9062006301		OM 904 LA
9062005101		OM 924 LA
9062004301		OM 926 LA
9062004001		



Package Weight : **11,300 kg**
Package Dimensions : **24x40x16 cm**



03.1303.00



09.2315.00
Ref : 4149810205



09.1537.00
Ref : 0149972845



16.3050.00



01.2301.00

REPAIR KIT

15.3050.00

Replaced Old Famco No : FM151751010

Oem Ref	Vehicle/Model	Engine
		OM 904 LA
		OM 924 LA
		OM 926 LA



WATER PUMP

12.3200.00

Replaced Old Famco No : FM184871000

Oem Ref	Vehicle/Model	Engine
5422002501		OM 501 LA OM 502 LA

*impeller: \varnothing 125 mm width: 12 mm

*with metal gasket



Package Weight : **15,200 kg**
 Package Dimensions : **24x40x21 cm**

**02.2302.00****09.2329.00**

09.4004.00
 Ref : 0012012619



01.2305.00
 Ref : 5422010007
 \varnothing 125x15 12mm

REPAIR KIT

15.3200.00

Replaced Old Famco No : FM184871010

Oem Ref	Vehicle/Model	Engine
	ACTROS	OM 501 LA
	420kW 542.924	OM 502 LA
	448kW 542.956	

* impeller: \varnothing 125 mm width: 12 mm
 * with metal gasket



WATER PUMP

12.3210.00

Replaced Old Famco No : FM184881000

Oem Ref	Vehicle/Model	Engine
5422002601		OM 502 LA

*impeller: ϕ 125 mm width: 12 mm

*with metal gasket

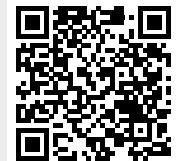

Package Weight : **15,900 kg**
Package Dimensions : **24x40x21 cm**



02.2302.00



09.2329.00



09.4004.00
Ref : 0012012619



01.2305.00
Ref : 5422010007
 ϕ 125x15 12mm

REPAIR KIT

15.3210.00

Replaced Old Famco No : FM184881010

Oem Ref	Vehicle/Model	Engine
	ACTROS 420kW 542.924 448kW 542.956	OM 502 LA

* impeller: ϕ 125 mm width: 12 mm
* with metal gasket

Remarks
to fit water pumps:
5422002601
5422002201
5422001801



WATER PUMP

12.3330.00

Replaced Old Famco No : FM184891000

Oem Ref	Vehicle/Model	Engine
5412002301	541.970 - 978 - 980 -	OM 501 LA
5412002001	981 - 999	

*impeller: \varnothing 125 mm width: 8 mm

*with metal gasket



Package Weight : **11,450 kg**
 Package Dimensions : **24x40x16 cm**



03.1403.00
 Ref : 4032020414



09.2328.00
 Ref : 4032001802



09.4004.00
 Ref : 0012012619



01.2304.00
 Ref : 4412010207
 \varnothing 125x15 8 mm

REPAIR KIT

15.3180.00

Replaced Old Famco No : FM180031010

Oem Ref	Vehicle/Model	Engine
	ACTROS	OM 501 LA
	315kW 521.940	
	230kW 541.920	
	315kW 541.921	
	260kW 541.922	
	290kW 541.923	
	315kW 541.925	

*impeller: \varnothing 125 mm width: 8 mm

*with metal gasket

Remarks

to fit water pumps:

5412001201 5412001401
 5412001101
 5412000101



WATER PUMP

12.3350.00

Replaced Old Famco No :

Oem Ref	Vehicle/Model	Engine
4722001001		OM 470 LA -470.903
4722000401		OM 470 LA -470.904
4722000101		OM 470 LA -470.906
4722000001		OM 470 LA -470.907
		OM 470 LA -470.908
		OM 470 LA -470.917
		OM 471 LA -471.900
		OM 471 LA -471.901
		OM 471 LA -471.902
		OM 471 LA -471.903
		OM 471 LA -471.905
		OM 471 LA -471.906
		OM 471 LA -471.909
		OM 471 LA -471.910
		OM 471 LA -471.911
		OM 471 LA -471.913
		OM 471 LA -471.914
		OM 471 LA -471.915
		OM 473 LA -473.908
		OM 473 LA -473.909



Package Weight : **2,400 kg**
Package Dimensions : **22,5x24,5x16 cm**



03.1304.00



09.2352.00



09.4002.00
Ref: 21014261



08.2301.00
Ø 103 mm



08.3301.00
Ref: 4722020210



09.1538.00
Ref: 4722010080

WATER PUMP

13.3350.00

Replaced Old Famco No :

Oem Ref	Vehicle/Model	Engine
		OM 470 LA
		OM 471 LA
		OM 473 LA



Package Weight : **3,400 kg**
Package Dimensions : **22,5x24,5x16 cm**



WATER PUMP

12.3360.00

Replaced Old Famco No :

Oem Ref	Vehicle/Model	Engine
9362001501		OM 934 - 933.911
9362000801		OM 934 - 933.912
9362001101		OM 934 - 933.913
		OM 934 - 933.915
		OM 934 - 933.916
		OM 934 - 933.951
		OM 934 - 933.952
		OM 934 - 934.911
		OM 934 - 934.913
		OM 936 - 935.951
		OM 936 - 935.952
		OM 936 - 935.953
		OM 936 - 936.910
		OM 936 - 936.912

**impeller: ø 87,5 mm*

Package Weight : **3,000 kg**
 Package Dimensions : **27x28x16 cm**

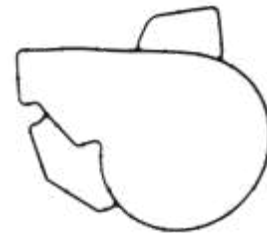

WATER PUMP

12.3361.00

Replaced Old Famco No :

Oem Ref	Vehicle/Model	Engine
9362001601		OM 934 - 933.951
9362001201		OM 934 - 933.952
9362000701		OM 936 - 935.951
		OM 936 - 935.952
		OM 936 - 935.953
		OM 936 - 935.954
		OM 936 - 936.910
		OM 936 - 936.912
		OM 936 - 936.916

**impeller: ø 99 mm*

Package Weight : **3,000 kg**
 Package Dimensions : **27x28x16 cm**

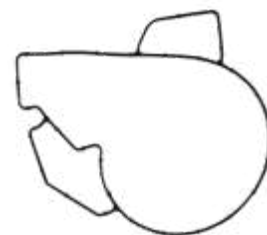

WATER PUMP

12.3362.00

Replaced Old Famco No :

Oem Ref	Vehicle/Model	Engine
9362001701		M 936 G - 936.991
9362001301		M 936 G - 936.993
9362000601		OM 934 - 933.951
		OM 934 - 933.952
		OM 936 - 935.911
		OM 936 - 935.912
		OM 936 - 935.913
		OM 936 - 935.914
		OM 936 - 935.951
		OM 936 - 935.952
		OM 936 - 935.953
		OM 936 - 935.954
		OM 936 - 936.910
		OM 936 - 936.912
		OM 936 - 936.916
		OM 936 - 936.919
		OM 936 - 936.923
		OM 936 - 936.972
		OM 936 - 936.973
		OM 936 H - 936.980

*impeller: ø 101 mm



Package Weight : **3,000 kg**
Package Dimensions : **27x28x16 cm**



02.1301.00



09.2364.00



09.4002.00
Ref : 21014261

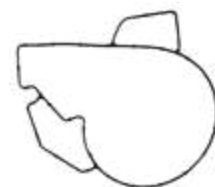

09.1575.00
Ref : 9362010280



08.2302.00
Ø 87,5mm



08.2303.00
Ø 99mm



08.2304.00
Ø 101mm

WATER PUMP

12.3370.00

Replaced Old Famco No :

Oem Ref	Vehicle/Model	Engine
4032007501		ADE 423 T1 - 493.900-501
4032006401		501

*impeller: \varnothing 125 mm (closed)

Package Weight : **12,450 kg**
 Package Dimensions : **24x40x16 cm**



03.1403.00
 Ref : 4032020414



09.2328.00
 Ref : 4032001802



09.4004.00
 Ref : 0012012619



01.2305.00
 Ref : 4032011307
 \varnothing 125x15 12mm



09.5168.00
 Ref : 4422010280

WATER PUMP

12.3371.00

Replaced Old Famco No :

Oem Ref	Vehicle/Model	Engine
4222001201		
4222000701		

*impeller: \varnothing 135 mm

Package Weight : **12,450 kg**
 Package Dimensions : **24x40x16 cm**



WATER PUMP

12.3310.00

Replaced Old Famco No : FM184901000

Oem Ref	Vehicle/Model	Engine
5412002701		OM 501 LA
5412001801		

*with metal gasket



Package Weight : **14,150 kg**
Package Dimensions : **24x40x16 cm**



WATER PUMP

12.3320.00

Replaced Old Famco No : FM184911000

Oem Ref	Vehicle/Model	Engine
5412001901		OM 501 LA
5412002601		
5412002801		

*with metal gasket



Package Weight : **14,500 kg**
Package Dimensions : **24x40x16 cm**



www.famco.com.tr



*Save water
For the future...*

FAMCO[®]
GENUINE

VOLVO

SCANIA

MERCEDES-BENZ

MAN

DAF

RENAULT

IVECO

OTHERS

*Special production solutions
for special customers.*



VOLVO

SCANIA

MERCEDES-BENZ

MAN

DAF

RENAULT

IVECO

OTHERS

www.famco.com.tr

EXPORT TO
MORE THAN
45
COUNTRIES



FAMCO[®]
GENUINE

VOLVO

SCANIA

MERCEDES-BENZ

MAN

DAF

RENAULT

IVECO

OTHERS

VOLVO

SCANIA

MERCEDES-BENZ

MAN

DAF

RENAULT

IVECO

OTHERS



CHOICE OF LEADERS



FAMCO
GENUINE

FA-ME OTOMOTİV DÖKÜM MAKİNE SAN. ve TİC. LTD. ŞTİ.

Büyükkayacık Osb Mah. 5. Org. Sanayi Bölgesi 511 Nolu Sk.
No:13 Selçuklu / KONYA

Phone: +90 332 345 22 55 (pbx) - Fax: +90 332 345 00 15
www.famco.com.tr - sales@fameotomotiv.com



TUV NORD

DO ajans
www.doajans.com